

SWIT®

SWIT Electronics Co., Ltd.

Model: S-1273F

27" Broadcast Studio LCD Monitor

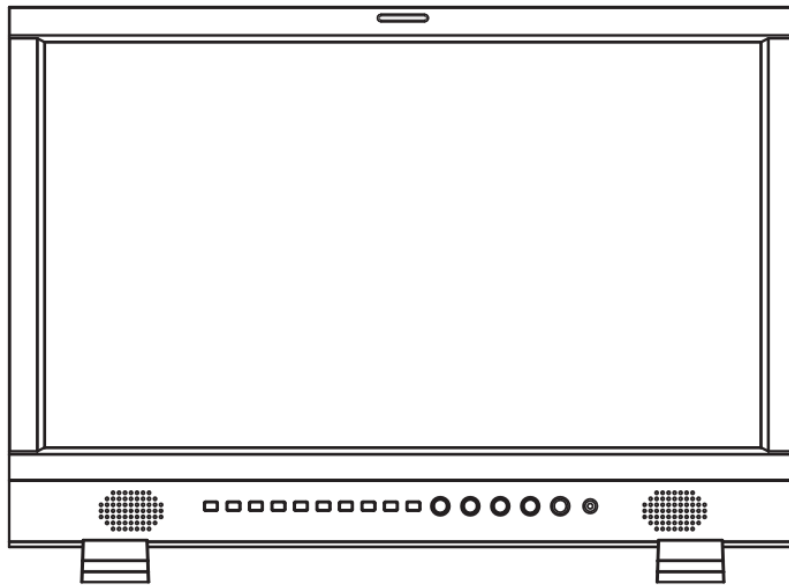

User Manual

Ver: A

Please read this User Manual
throughout before using.

Preface

1. All internal technologies of this product are protected, including device, software and trademark. Reproduction in whole or in part without written permission is prohibited.
2. All brands and trademarks of SWIT Electronics Co., Ltd. are protected and other relative trademarks in this user manual are the property of their respective owners.
3. Due to constant effort of product development, SWIT reserves the right to make changes and improvements to the product described in this manual without prior notice.
4. The warranty period of this product is 2 years, and does not cover the following:
 - (1) Physical damage to the surface of the products, including scratches, cracks or other damage to the LCD screen or other externally exposed parts;
 - (2) The LCD dot defects are not over three;
 - (3) Any damage caused by using third-party power adaptors;
 - (4) Any damage or breakdown caused by use, maintenance or storage not according to the user manual;
 - (5) The product is disassembled by anyone other than an authorized service center;
 - (6) Any damage or breakdown not caused by the product design, workmanship, or manufacturing quality, etc;

* Any sales personnel have no rights to provide additional warranty.
5. For any suggestions and requirements on this product, please contact us through phone, fax, Email, etc.

SWIT Electronics Co., Ltd.

Address: 10 Hengtong Road, Nanjing Economic and Technological Development Zone,
Nanjing 210038, P.R. China

Phone: +86-25-85805753

Fax: +86-25-85805296

Email: contact@swit.cc

Website: <http://www.swit.cc>

Maintenance

Warning

1. In order to reduce the risk of fire and electrical shock, do not lay this product in rain or damp places.
2. Please keep away from the strong magnetic field; it may cause the noise of the video and audio signals.

The power

1. Please use the power adapter provided or recommended by the manufacturer in order to avoid damage.
2. For a third party power adapter, please make sure the voltage range, supplied power, and polarity of power lead are fit.
3. Please disconnect the power cable under the following situations:
 - (A). If you do not operate this monitor for a period of time;
 - (B). If the power cable or power adaptor is damaged;
 - (C). If the monitor housing is broken.

The monitor

1. Please don't touch the screen with your fingers, which would probably deface the screen.
2. Please don't press the screen; the LCD is extremely exquisite and flimsy.
3. Please don't lay this product on unstable place.

Cleaning

1. Please clean the screen with dry and downy cloth or special LCD cleanser.
2. Please do not press hard when cleaning the screen.
3. Please do not use water or other chemical cleanser to clean the screen. The chemical may damage the LCD.

Contents

Preface.....	2
Maintenace	3
Contents.....	4
Packing List	4
Introduction	4
Installation Dimensions.....	5
Operation Instructions	8
Front Panel.....	8
OSD.....	9
Rear Panel	11
Main Menu	12
Specification.....	20
Trouble-Shooting	21

Packing List

Standard Package:

1. Battery plate (V-mount or Gold mount option)
2. Desktop Stand Feet
3. Power adaptor + power cable

Introduction

S-1273F adopts IPS LCD panel, with resolution 1920×1080 and wide viewing angle H178°/V178°. It supports 2 x 3GSDI (Level A/B), 1 x HDMI, 1 x CVBS, 1 x Y/Pb/Pr, 1 x VGA and 1 x analog audio input. It also supports 2 x 3GSDI, 1 x HDMI, 1 x CVBS and 1 x analog audio loop through output.

Features:

- Support multiple Aspect Ratio and scan modes
- Support multiple Marker selection (Marker, Safety Area)
- Powerful audio and video analysis functions
- Support multiple functions user-defined (Source ID, function keys, GPI)
- Multiple power supply methods to meet different requirements
- TSL UMD (RS485&RS232) ,Tally, GPI Control
- USB firmware upgrade
- Support 2K display
- Support green energy saving mode
- Support 3DLut calibration and Camera Log conversion

Installation Dimension

The main body (in mm)

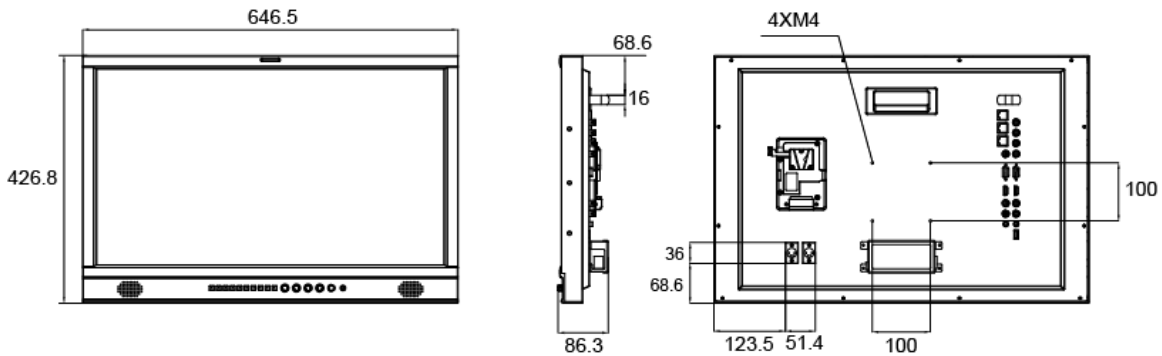

With desktop stand feet (in mm)

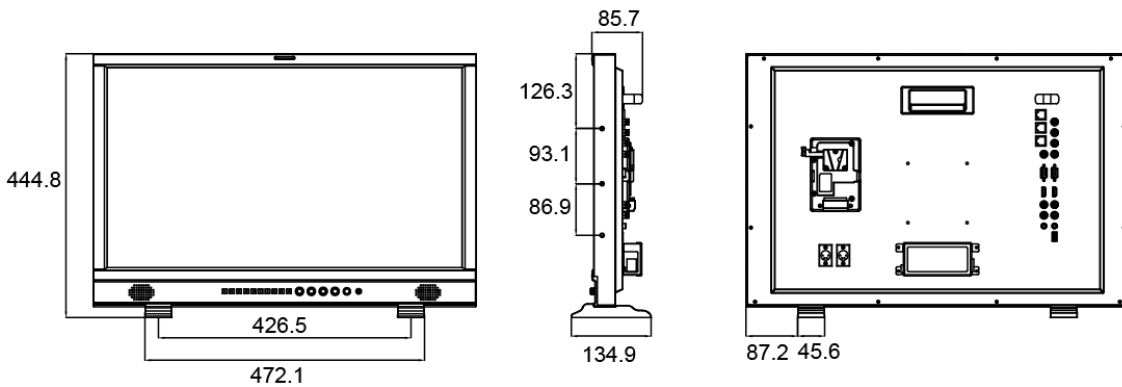

For optional purchase

Item Name	Item Model
V-mount battery plate	S-7004S
Gold-mount battery plate	S-7004A

1. Battery plate

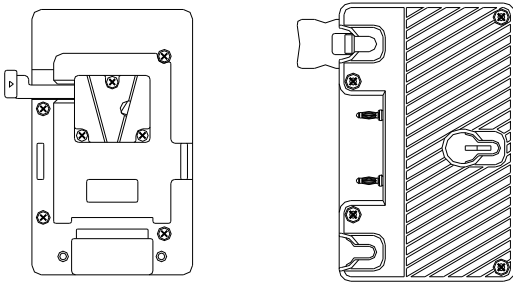

S-7004S

S-7004A

Installation

1. Take off the rub cover on the rear panel; see Fig (1).
2. Insert the DC cable of S-7004S/A into the hole, and plug onto the power socket inside the hole; see Fig (2).
3. Fix the battery plate onto the rear panel by the supplied screws; see Fig (3).

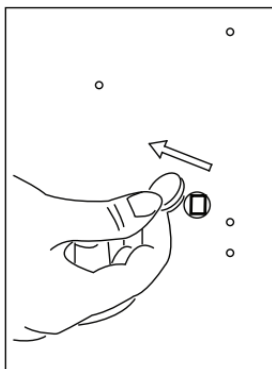

Fig (1)

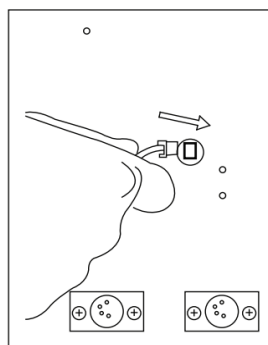

Fig (2)

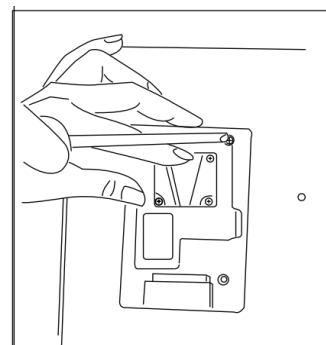
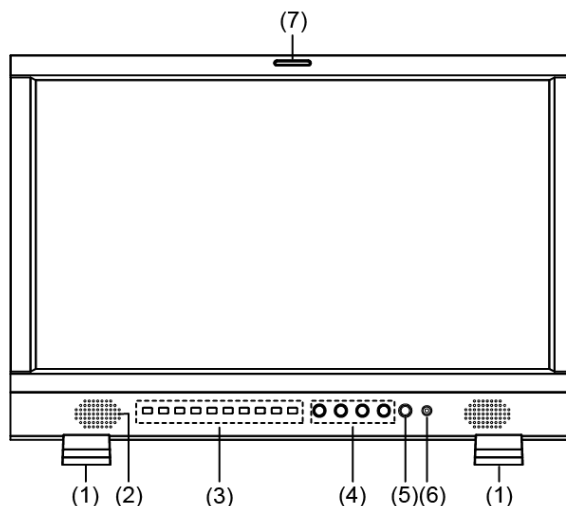

Fig (3)

Operation Instructions

•Front Panel



(1) Desktop Stand Feet

(2) Speaker: For SDI/HDMI embedded audio and analog audio monitoring. (Will not work if earphone is plugged in)

(3) Illuminated Push Button



SDI1: Press “SDI1” to switch to SDI input 1

SDI2: Press “SDI2” to switch to SDI input 2

HDMI: Press “HDMI” to switch to HDMI input

ANALOG: Press “ANALOG” to select from CVBS, VGA, Y/ Pb / Pr signal

F1~F4: User definable function keys; please see details in “4.Function Key” under “Main Menu”.

WFM: Waveform shortcut key, press “WFM” to quickly turn on or turn off the waveform, and select the type of the waveform.

DISPLAY: Press “DISPLAY” to turn on or turn off relevant status information, audio and video waveform.

Press “DISPLAY” to release one key quit the menu when Menu is opened.

(4) Rotary Knob

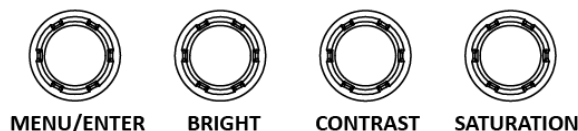

MENU/ENTER: When the menu is inactivated, press “MENU/ENTER” to turn on the main menu

Revolve “MENU/ENTER” to adjust settings or parameters, and press to apply

When the menu is inactivated, revolve “MENU/ENTER” to adjust the sound volume

BRIGHT: 0-100 value adjustment and the default value is 50

CONTRAST: 0-100 value adjustment and the default value is 50

SATURATION: 0-100 value adjustment and the default value is 50

(5) POWER: Power on/off

(6) PHONE: 3.5mm earphone socket, for SDI/HDMI embedded audio and analog audio monitoring.

(7) TALLY Light: Red, Green and Yellow 3-color TALLY indicator

·OSD

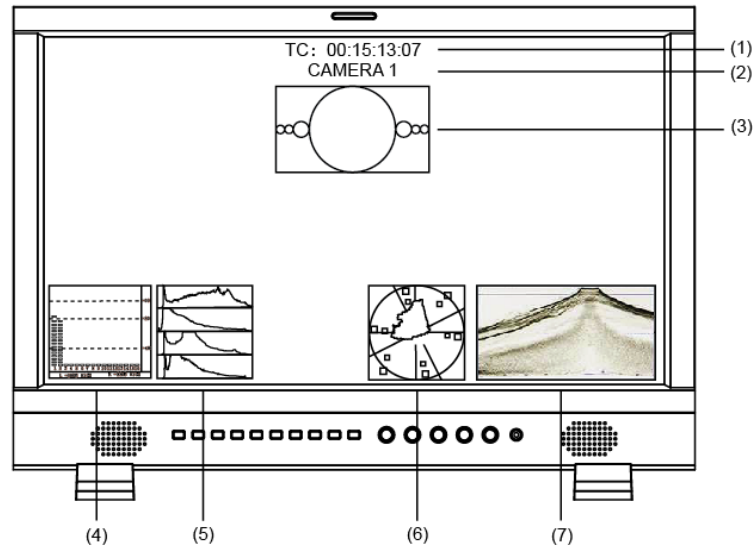

(1) Timecode (SDI)

Under SDI input, it can display Timecode. If no Timecode information is detected, it will be displayed as “TC UNLOCKED”.

User can set function keys F1~F4 or GPI pins as “Timecode” to turn on or off this function.

(2) UMD

Set up the UMD under “UMD” submenu.

(3) AFD (SDI)

User can set function keys F1~F4 or GPI pins as “AFD” to turn on or off this function. If no relevant information is detected, it will be displayed as “AFD: UNLOCKED”.

(4) Audio Bar

Monitor the audio information. The relevant parameters like position, audio channels and blending, etc. can be changed under “Audio Bar” submenu.

User can set function Keys F1~F4 or GPI pins as “Audio Bar” to turn on or off this function.

(5) Histogram

User can set function Keys F1~F4 or GPI pins as “Histogram” to turn on or off this function.

(6) Vector

The relevant parameters like Vector position, Vector color and Vector blending, etc. can be changed under “Vector” submenu.

User can set function Keys F1~F4 or GPI pins as “Vector” to turn on or off this function.

(7) Waveform

Press “WFM” on the front panel to turn on/of this function. The relevant parameters like WFM position, WFM color and WFM blending, etc. can be changed under “Waveform” submenu.

Introduction of audio and video functions

◆ 16-ch embedded audio meters

Under 3G/HD/SD SDI, it displays 16 channels embedded audio meters. Under HDMI, it displays 8 channels embedded audio meters. The audio meter is green, and will turn yellow when audio exceeds -20dB, and turn red when audio exceeds -9dB.

◆ Audio alarm

If the embedded audio value is too low or no embedded audio, it will display “MUTE” or “UNLOCKED” in the audio bar.

◆ Timecode (SDI)

Under SDI input, it can display the SMPTE time code (VITC1, VITC2 or LTC) on the top of the screen, which is used extensively for synchronization, and for logging and identifying material in recorded media. If no Timecode information is detected, it will be displayed as “TC UNLOCKED”.

◆ Waveform (Y, Cb, Cr, R, G, B)

Under SDI and HDMI input, totally 6 kinds of waveforms which are Y, CB, CR, R, G and B can be selected so as to check the brightness and chroma distribution.

◆ Vector

The displayed vector scope pattern is available under both SDI and HDMI, represents saturation as distance from the center of the circle, and hue as the angle, in standard position, around it.

◆ Histogram (R, G, B)

The histogram is a bar graph that shows the distribution of luminance values in the picture. There're R, G, B histograms that individually displayed simultaneously, available under both SDI and HDMI.

◆ Internal Color Bar

Under SDI and HDMI input, it has 100% internal color bar which helps analyze the monitor color and adjust the display parameter.

User can set function Keys F1~F4 or GPI pins as “color bar” to turn on or off this function.

◆ Peaking focus assist (red/blue switch)

The Peaking focus assist function is to mark the sharpest edges of the image with red or blue color under SDI and HDMI input, for users to check if the subjects are focused.

User can set function Keys F1~F4 or GPI pins as “Focus Assist” to turn on or off this function.

◆ Zebra stripes

Zebra Stripes are used to check if the image is over exposed or not by showing black and white lines on the monitor. It is considered over exposed when luminance value exceeds 90%.

User can set function Keys F1~F4 or GPI pins as “Zebra” to turn on or off this function.

◆ **Freeze Frame**

The freeze frame is to capture and display the current broadcast frame.

User can set function Keys F1~F4 or GPI pins as “Freeze Frame” to turn on or off this function.

◆ **R/G/B/Mono**

R/G/B/Mono is to display only the blue/red/green primary signal or the luminance signal only so as to monitor the image noise.

User can set function Keys F1~F4 or GPI pins as “R/G/B/Mono” to turn on or off this function.

◆ **False Color**

The false color is used to aid in the setting of camera exposure. Under false color mode, there’s a color chart on the bottom of screen for reference. The color from the dark to the bright will be displayed as blue, cyan, green, yellow, orange and red in a consecutive way. User can set function Keys F1~F4 or GPI pins as “False color” to turn on or off this function.

◆ **AFD (SDI)**

It is the abbreviation of active format description. AFD is to display the SDI embedded AFD information graphically on the screen.

◆ **H/V Delay (SDI)**

Under SDI input, H/V Delay can be used to display line/field blanking signal, and to observe the horizontal and vertical synchronous signal.

◆ **UMD**

When using external control unit, it can display the video source ID and tally information on the screen.

◆ **Image Flip**

Horizontal, vertical, horizontal and vertical two-way image flip function.

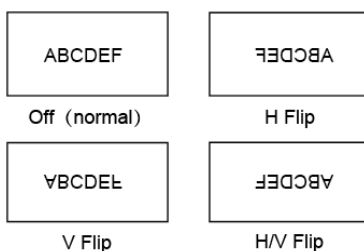

·Rear Panel

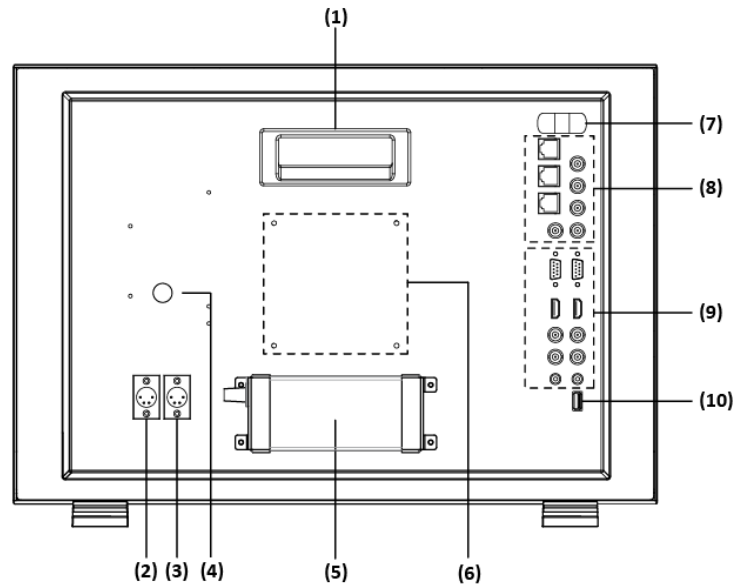

- (1) Handle
- (2) DC IN 11V-17V BACK UP: Back up power input, connect with DC11V~17V 4-pin XLR power adapter. (Pin 1: Negative, Pin 4: Positive)
- (3) DC IN 11V-17V MAIN: Main power input, connect with DC11V~17V 4-pin XLR power adapter. (Pin 1: Negative, Pin 4: Positive)
- (4) Reserved battery plate power socket: Take off the rub cover; connect V-mount or Gold mount battery plate to the power socket.
- (5) Power adaptor
- (6) VESA Mount: Standard 10×10cm VESA desktop stand installation
- (7) 1U plastic bump: Protect the BNC sockets on the rear panel
- (8) Socket1

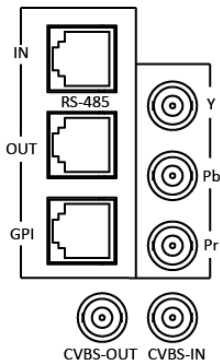

RS-485 (IN, OUT): TSL UMD control port
 GPI: GPI control port
 Y/Pb/Pr: Y/Pb/Pr input
 CVBS-IN: CVBS input (BNC connector)
 CVBS-OUT: VBS output (BNC connector)

(9) Socket 2

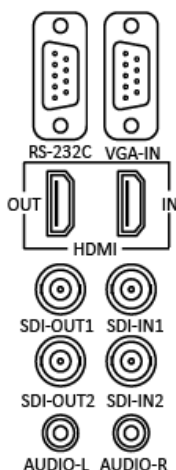

RS-232C: TSL UMD control port
 VGA-IN: VGA input
 HDMI (IN, OUT): HDMI input/output (HDMI-A connector)
 SDI-IN1: SDI input (BNC connector)
 SDI-OUT1: SDI loop through output from SDI-IN1 (BNC connector)
 SDI-IN2: SDI input (BNC connector)
 SDI-OUT2: SDI loop through output from SDI-IN2 (BNC connector)
 AUDIO-L: Left channel audio signal input (3.5mm RCA)
 AUDIO-R: Right channel audio signal input (3.5mm RCA)

(10) USB socket

Main Menu

S-1273F has OSD to adjust the parameters and settings, for example: Picture, color temp., function keys, etc.

1. Press “MENU/ENTER” button, the main menu will popup from the left top of the screen. The selected main menu highlights in yellow.

Main Menu	Status
Exit&Status	HDMI XXX
Picture	User Profile XX
Color Temp	Color Temp XXXX
Function Key	Scan Mode XXX
GPI	Freeze Frame XX
UMD	Odd/Even Frame XX
Marker	F1 XX
Audio	F2 XX
Vector	F3 XX
Waveform	F4 XX
Display	F5 XX
System	System Version XX
Color Measurement	
OSD	
Key Inhibit	

2. Revolve “MENU/ENTER” to select submenu, the selected submenu highlights in yellow, press “MENU/ENTER” to apply and enter into the selected submenu’s items.

3. Revolve “MENU/ENTER” to select the item which needed to adjust, press “MENU/ENTER”, the selected item and its parameters will be highlighted in yellow.

Main Menu	Marker
Exit&Status	Exit
Picture	Marker < XXX >
Color Temp	Marker Select < 15:9 >
Function Key	Safety Area < XXX >
GPI	Fit Marker < XX >
UMD	Center Marker < XX >
Marker	Marker Color < XX >
Audio	Marker Outside < XX >
Vector	
Waveform	
Display	
System	
Color Measurement	
OSD	
Key Inhibit	

4. Revolve “MENU/ENTER” to change the selected item’s parameter, press “MENU/ENTER” to apply and save the settings.

5 Revolve “MENU/ENTER” to select “Exit”, press “MENU/ENTER” to quit submenu. Select “Exit & Status” under the Main Menu and press to quit Main Menu.

Notice:

- * The items in gray can not be set up.
- * If there is no operation under the setted time, the menu will automatically save settings and quit.
- * If the key inhibit function is turned on, except key inhibit function, all other items are in grey. Please turn off the key inhibit function to adjust the items.

Submenu introduction (the default values are marked with underline)

1. Exit & Status

Displays the current status, the details are as down below:

Exit&Status	HDMI* ¹	1080p@50Hz
	User Profile	Default
	Color Temp	6500K
	Scan Mode	Normal
	Freeze Frame	Off
	Odd/Even Frame	Off
	F1* ²	Audio Bar
	F2	Vector
	F3	Zebra
	F4	Mute
	F5	Marker
	System Version	VXXX-XX

*1 Display the current video signal and format

*2 Display the current function keys setup

2. Picture

To adjust picture parameters

Picture	Exit	
	Contrast	0-100, <u>50</u>
	Brightness	0-100, <u>50</u>
	Saturation	0-100, <u>50</u>
	Sharpness	0-100, <u>50</u>
	Hue	0-100, <u>50</u>
	Backlight	0-100, <u>50</u>

3. Color Temp

To select different color temperature or setup user-defined color parameters.

Color Temp	Exit	
	Gamma	2.2、 <u>2.4</u> 、2.6
	Color Temp	<u>6500K</u> 、5600K、9300K、User
	Red Gain	0-255, 128
	Green Gain	0-255, 128
	Blue Gain	0-255, 128
	Red Bias	0-255, 128
	Green Bias	0-255, 128
	Blue Bias	0-255, 128

* Only "Color Temp" is set to "User", the Red/Blue/Green Gain or Red/Blue/Green Bias can be adjusted.

4. Function key

To define the F1~F4 function keys.

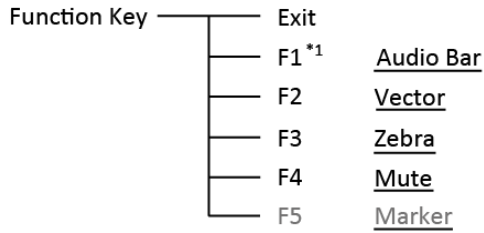

*1 Function keys F1-F4 can be set as the down below functions:

Audio Bar, Histogram, False Color, AFD, H/V Delay, R/G/B/Mono, Marker, Color Bar, UMD, Audio Alarm, Focus Assist, Aspect Ratio, Scan Mode, Zoom Mode, Mute, Freeze Frame, Flip Mode, CVBS, YPbPr, VGA, Color Temp, Time Code, Zebra, Vector.

For example: Set F3 to "R/G/B/Mono" under "Function key" submenu. User can press F3 on the front panel to adjust the parameters of "R/G/B/Mono", and the "R/G/B/Mono" will change and follow the sequence: Blue Only → Red Only → Green Only → Mono → Off.

5. GPI

User can set GPI pins to relevant functions to turn on or off this function.

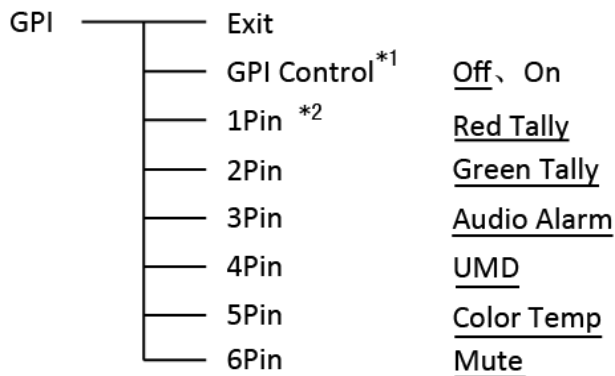

*1 When "GPI control" is set to "On", the monitor can be operated through external GPI control unit.

*2 The GPI pins can be set to the down below functions:

Red Tally, Green Tally, Yellow Tally, Aspect Ratio, Scan Mode, Zoom Mode, Mute, Freeze Frame, Flip Mode, Color Temp, Time code, Zebra, Vector, Audio Bar, Histogram, False Color, AFD, H/V Delay, R/G/B/Mono, Marker, Color Bar, UMD, Audio Alarm, Focus Assist.

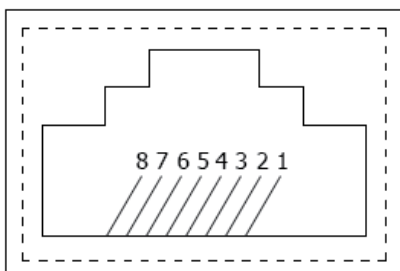

Pin	1	2	3	4
GPI	GPI_1	GPI_2	GPI_3	GPI_4
Pin	5	6	7	8
GPI	GPI_5	GPI_6	NC	GND

When connecting the GPI pin with ground, the setted function will be turned on, and goes out when disconnecting.

Example 1: Under "GPI" submenu, set "GPI control" to "On", set "2 Pin" to "Red Tally", when the pin 2 of the external GPI control unit is connected with ground, the Tally light on the front panel will turn red. When disconnected, the tally light will turn off.

Example 2: Under "GPI" submenu, set "GPI control" to "On", set "6 Pin" to "Scan Mode", when the pin 6 of the external GPI control unit is connected with ground, the Scan mode will change and follow the sequence: "Normal" → "Overscan" → "Native".

6.UMD

Support "TSL UMD Protocol-V3.1/V4.0" provided by Television System LTD

UMD	Exit	
	RS485 Address	1-126
	Position	Top, Bottom
	Size	Normal, Mid-Large, Large
	Color	Red, White, Black, Blue, Green, Yellow
	Display Type	Source ID, UMD
	Baud Rate	38400, 9600, 19200
	Parity	Even, None
	Serial Port	RS485, RS232
	Source ID	CAMERA 1

Setup Source ID:

Select "Source ID", revolve "MENU/ENTER" to select the letters and press "MENU/ENTER" to input. Max 8 letters are supported. Select "Exit" to quit and save settings, the source ID will be displayed on top or bottom of the screen.

UMD setup:

- (1) Connect the external control equipment with S-1273F
- (2) Set "Display Type" to "UMD" under UMD submenu
- (3) Set "Serial Port" to RS485 or RS232 according to the port type of external control equipment
- (4) Make sure the "address", "Baud Rate", "Parity" the same
- (5) Adjust the external control equipment and send UMD command, the UMD information will be display as the right photo.

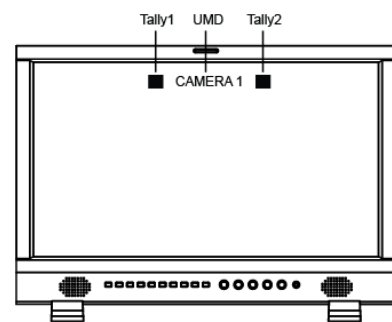

User can set the character and color of the UMD and the color of Tally1 and Tally2.

RS485 pin sequence and definition:

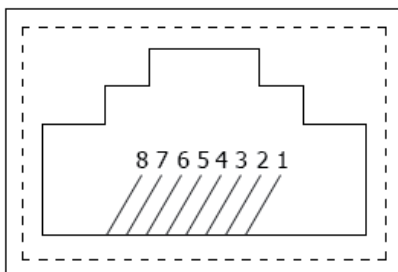

Pin	IN Signal	OUT Signal
1	TXD+	TXD+
2	TXD-	TXD-
3	RXD+	RXD+
4	NC	NC
5	NC	NC
6	RXD-	RXD-
7	NC	NC
8	GND	GND

RS232 pin sequence and definition:

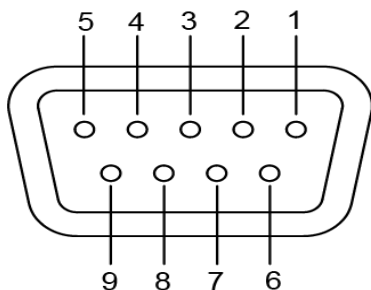

Pin	Signal
1	NC
2	RXD
3	TXD
4	NC
5	GND
6	NC
7	RTS
8	CTS
9	NC

7. Marker

Marker	Exit	
	Marker	<u>Off</u> , On
	Marker Select	Off, 4:3, 13:9, 14:9, 15:9, 16:9, <u>1.85:1</u> , 2.35:1
	Safety Area	Off, 80%, 85%, <u>90%</u> , 93%, 95%
	Fit Marker*1	<u>Off</u> , On
	Center Marker	Off, <u>On</u>
	Marker Color	<u>White</u> , Red, Green, Blue, Black, Gray
	Marker Outside	Off, <u>Gray</u> , Black

*1 When "Fit Marker" is Off, the size of safety area is benchmarked against the actual display screen, accounting for 80% ~ 95% of actual display screen. When "Fit Marker" is On, the size of safety area is benchmarked against the area inside the scales marker, accounting for 80% ~ 95% of the area inside the scales marker.

Example:

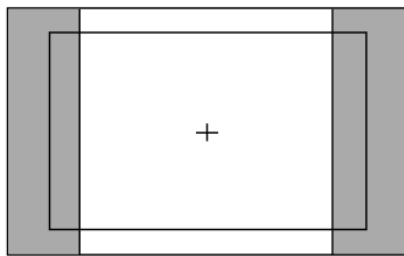
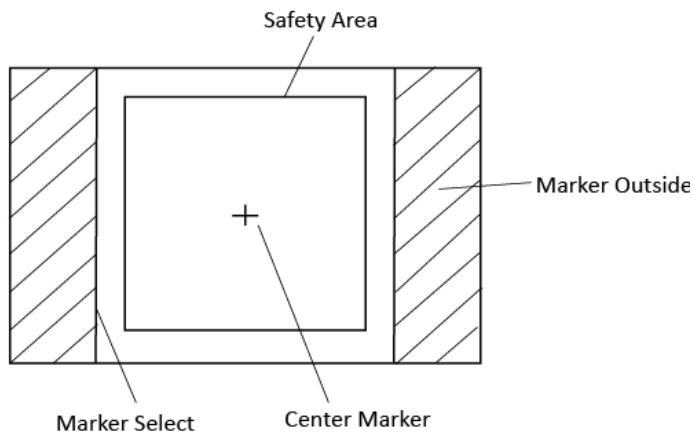

Aspect ratio: 4:3
 Safety Area: 85%
 Center Marker: On
 Fit Marker: Off

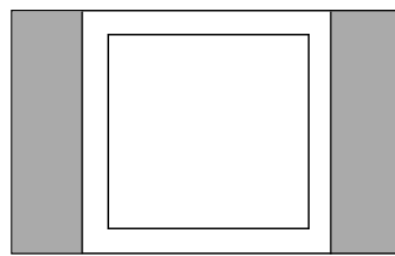

Aspect ratio: 4:3
 Safety Area: 85%
 Center Marker: Off
 Fit Marker: On

8. Audio

Audio	Exit	
	Audio Bar	<u>Off</u> 、On
	Bar Frame *1	Off、 <u>On</u>
	Bar Position	<u>Top Right</u> 、Bottom Left、Bottom Right、Top Left
	Bar Blending	<u>Low</u> 、Off、High
	Audio Alarm *2	<u>Off</u> 、On
	Select Channel *3	Channel <u>1-2</u> 、1-8、1-16
	Left Channel *4	CH1-CH16, <u>CH1</u>
	Right Channel	CH1-CH16, <u>CH2</u>

*1 When “Bar Frame” is set to “Off”, only the audio meter will be displayed
When “Bar Frame” is set to “On”, frame and real-time audio value will be displayed.

*2 Select Channel
Under analog signal, only channel1-2 can be displayed.
Under HDMI signal, channel1-2 and 1-8 can be selected.
Under SDI signal, channel 1-2, 1-8 and 1-16 can be selected

*3 When “Audio Alarm” is set to “On”, if no embedded audio is detected, the audio bar will display “UNLOCKED”. If the audio value is too low, the audio bar will display “MUTE”.

*4 Audio channels can be selected to output according to the requirements.
When the current “Select Channel” is set to “Channel1-2”, the left channel and right channel output can be selected from Channel1 or channel2.
When the current “Select Channel” is set to “Channel1-8”, the left channel and right channel output can be selected from Channel1 to channel8.
When the current “Select Channel” is set to “Channel1-16”, the left channel and right channel output can be selected from Channel1 to channel16.
In audio bar, the left channel information will be in green, and the right channel information will be in red.

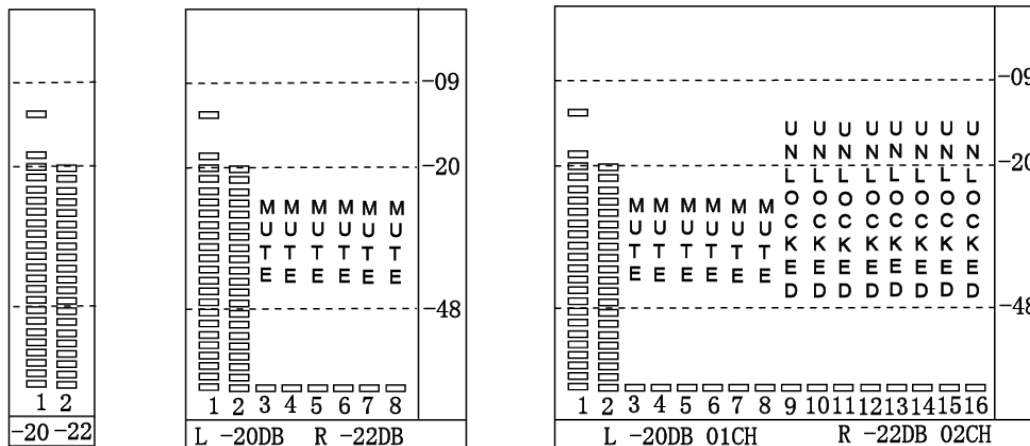

Channel 1-2

Channel 1-8

Channel 1-16

9. Vector

Vector	Exit	
	Vector	<u>Off</u> , On
	Vector Position	<u>Bottom Right</u> , Center, Top Left, Top Right, Bottom Left
	Vector Blending	Off, <u>Low</u> , High
	Vector Color	Color, White, Green, <u>False Color</u>
	Histogram	<u>Off</u> , On
	Histogram Blending	<u>Low</u> , Off, High

10. Waveform

Waveform	Exit	
	Waveform	<u>Off</u> , On
	WFM Type	<u>Y</u> , Cb, Cr, R, G, B
	WFM Position	<u>Bottom Left</u> , Bottom Right, Center, Top Left, Top Right
	WFM Blending	<u>Low</u> , High, Off
	WFM Color	<u>White</u> , Green, False Color
	WFM Single Line	<u>Off</u> , On
	WFM Line Count *1	0-1079, <u>0</u>

*1: Only the "WFM Single Line" is set to "ON", the "WFM Line Count" can be adjusted.
 "WFM Single Line" is to display the selected line waveform of "WFM Line Count"

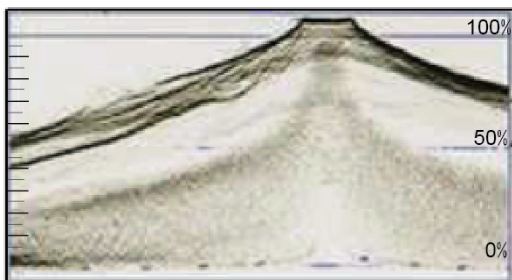

WFM Single Line: Off

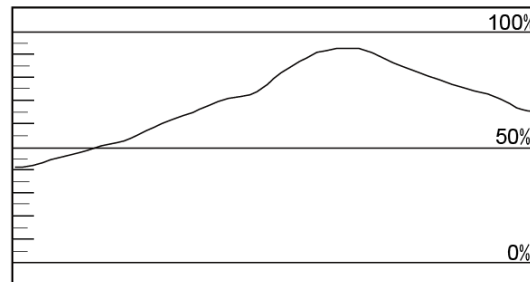

WFM Single Line: On

11. Display

Display	Exit	
	Waveform	<u>Off</u> , On
	Audio Bar	<u>Off</u> , On
	Vector	<u>Off</u> , On
	Zebra	<u>Off</u> , On
	Focus Assist	<u>Off</u> , Blue, Red
	Time Code	<u>Off</u> , On
	Histogram	<u>Off</u> , On
	False Color	<u>Off</u> , On
	AFD	<u>Off</u> , On
	H/V Delay	<u>Off</u> , On
	R/G/B/Mono	<u>Off</u> , Blue Only, Red Only, Green Only, Mono
	Color Bar	<u>Off</u> , On
	Marker	<u>Off</u> , On
	UMD	<u>Off</u> , On

12. System

System	Exit	
	Aspect Ratio	<u>16:9</u> 、Auto、4:3
	Scan Mode	<u>Normal</u> 、OverScan、Native
	Zoom Mode	<u>Off</u> 、Zoom1、Zoom2
	Odd/Even Frame	Off
	Color Space	Auto
	Freeze Frame	<u>Off</u> 、On
	Filp Mode	<u>Off</u> 、H Flip、V Flip、H/V Flip
	Recall Profile	<u>Factory</u> 、User1、User2、User3
	Save Profile	<u>User1</u> 、User2、User3
	Source Scan *1	<u>On</u> 、Off
	Logo *2	<u>On</u> 、Off
	Green Mode *3	Standby、Gray Backlight、 <u>Black Backlight</u>
	Idle Duration	Off、30Sec、 <u>2Hours</u> 、4Hours
	Update Driver *4	<u>No</u> 、Yse
	Update Kernel *5	<u>No</u> 、Yes

*1 Source Scan

When set to “Yes”, after turn on the monitor, the signal will be inspected and follow the sequence of “SDI1→SDI2→HDMI→YPbPr→VGA→CVBS”.

For example: if channel is selected to SDI2, SDI-IN2 has no input, and CVBS has input. When turn on the monitor, after automatic inspection, SDI2 has no recognizable signal, and CVBS has recognizable signal, then the input signal will be CVBS.

When set to “No”, update model will not be supported.

*2 Logo

When powered on, the screen will display SWIT logo.

*3 Green Mode

When no recognizable signal is detected and operation time reaches the time selected in “Idle Duration”, then the monitor will turn to green energy saving mode that is “Green mode”.

For example: Set the “Green Mode” to “Standby” and “Idle Duration” to “2Hours”, if no recognizable signal is detected for 2 hours, the monitor will turn to standby mode.

Under standby, Gray Backlight, Blacklight mode, press any button on the front panel, the monitor will be back to normal operation status.

*4, *5 Update Driver/ Kernel

- ① Download latest firmware files to USB disk, switch on the monitor, and insert to the USB port on rear panel of the monitor;
- ② Press “MENU/ENTER”, enter “Main Menu” - “System”, and select “Update Driver” or “Update Kernel”;
- ③ Set “Yes”, the monitor will upgrade automatically;
- ④ During firmware upgrade, the screen will display progress percentage. Pless do not cur off power during the upgrade;

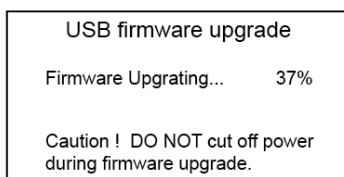

- ⑤ When succeed, the monitor will automatically re-start, and then upgrade will be finished.

13. Color Measurement

Color Measurement	Exit	
	Log Mode*1	<u>Off</u> , J-Log1, Log-C, S-Log2, S-Log3, C-Log, V-Log, RedLogFilm, User-Log
	1DLut	<u>Default</u> , User1, User2
	Color Measurement *2	<u>Off</u> , On
	Import *3	<u>3DLut.cube</u> , J-Log1.cube, Log-C.cube, S-Log2.cube, S-Log3.cube, C-Log.cube, V-Log.cube, RedLogFilm.cube, User-Log.cube, 1DLutUser1.csv, 1DLutUser2.csv
	Reset*4	<u>3DLut.cube</u> , J-Log1.cube, Log-C.cube, S-Log2.cube, S-Log3.cube, C-Log.cube, V-Log.cube, RedLogFilm.cube, User-Log.cube

*1 Camera Log conversion

When shooting with Log mode of the camera, you can select the corresponding Log conversion LUT, to convert the log mode video to standard ITU Rec.709 mode to monitor. A "User-Log" is provided for user defined LUT converting to Rec.709.

*2 Color Measurement enable

Before re-calibrate the monitor and start to measure the monitor display colors, please turn the "Color Measurement" on. And please turn the "Color Measurement" off when measurement finished and return to normal monitoring. It will turn off automatically when new cubes are imported or monitor restarted.

*3 Import re-calibrated cube or user log cubes

- (1) Calibrate the monitor by color meters and 3DLUT calibrating software, select 17x17x17, 6500K, Gamma 2.4 to calibrate, and get a correct cube file. (Konica Minolta CA-310 color meter and Spectral CalMAN software are recommended for accurate calibration)
- (2) Rename the re-calibrated cube as "3DLut.cube" (attention to the cap letters), and copy into USB stick root directory.
- (3) Insert the USB stick onto monitor USB port on the rear panel, select "Import" - "3DLut.cube" - "YES" to import the new cube.
- (4) You can change all the default camera log LUTs, User logs, and 1DLut colors by USB importing new cube file at the same file name.

*4 Reset to factory cubes

For any wrong cubes imported that caused wrong display colors, you can reset the cubes to factory cubes here.

14.OSD

OSD	Exit	
	OSD Language	<u>English</u> , Chinese
	OSD Blending	<u>Low</u> , Medium, High, Off
	OSD Duration	<u>10Sec</u> , 15Sec, 30Sec, 60Sec
	OSD Zoom	<u>Off</u> , On
	Key Led Brightness	<u>Low</u> , Medium, High, Off
	Tally-R Brightness	<u>High</u> , Low, Medium
	Tally-G Brightness	<u>High</u> , Low, Medium

15. Key Inhibit

Key Inhibit	Exit	
	Key Inhibit	<u>Off</u> , On

If the "Key Inhibit" is "On", there is no response when all the buttons except "MENU/ENTER" are pressed, the screen will be displayed as "Key Inhibit".

User can set "Key Inhibit" under "key Inhibit" submenu to "Off" to recover the functions of all buttons.

Specification

LCD Performance		
Size	27 inches	
Display area	598 mm×336 mm	
Resolution	1920×RGB×1080	
Color	8 bit	
Aspect ratio	16:94:3	
Brightness	250cd/m ²	
Contrast	1000:1	
Viewing Angle	178°(H)/178°(V)	
Input/output		
Input	BNC×2	3G/HD/SD-SDI input×2
	BNC×1	CVBS input
	BNC×3	Y/Pb/Pr input
	HDMI×1	HDMI input
	RS-485×2	GPI×1, UMD×1
	USB×1	
	VGA×1	VGA input
	RS-232C×1	UMD
Output	3.5mm RCA	L/R audio input
	BNC×2	3G/HD/SD-SDI Loop output
	BNC×1	CVBS Loop output
	HDMI×1	HDMI Loop output
	RS-485×1	UMD×1
	3.5mm×1	SDI/HDMI embedded audio output, analog audio output
Video Format		
CVBS	NTSC / PAL	
HDMI		480i / 576i / 480p / 576p
		1080i (60 / 59.94 / 50)
		720p (60 / 59.94 / 50)
		1080p (60 / 59.94 / 50 / 30 / 29.97 / 25 / 24 / 23.98)
SDI		1080psf (30 / 29.97 / 25 / 24 / 23.98)
	SMPTE-425M-A/B	1080p (60 / 59.94 / 50)
	SMPTE-274M	1080i (60 / 59.94 / 50)
		1080p (30 / 29.97 / 25 / 24 / 23.98)
	SMPTE-RP211	1080psf (30 / 29.97 / 25 / 24 / 23.98)
	SMPTE-296M	720p (60 / 59.94 / 50)
	SMPTE-125M	480i (59.94)
ITU-R BT.656	576i (50)	
SMPTE-2048-2		2048×1080p (23.98 / 24 / 25 / 29.97 / 30 / 50 / 59.94 / 60)
		2048×1080i (50 / 59.94 / 60)
VGA	640×480, 800×600, 1024×768, 1152×864, 1280×768, 1280×960, 1280×1024, 1600×1200	
Y/Pb/Pr	480i、480p、576i、576p、720p50、720p60、1080i50、1080i60、1080p50、1080p60	
General		
Working voltage	AC 100V~240V	
	DC / battery 11V-17V	
Power consumption	32W	
Working temperature	0℃~+40℃	
Working humidity	10%~90%	
Storage temperature	- 15℃~ + 60℃	
Storage humidity	10%~90%	
Dimensions	525×358×87mm	

Net weight (w/o stand)	6.2 Kg
------------------------	--------

Trouble-shooting

Symptom	Possible Causes	Solution
No display	The power is not turned on	Please check if the power is connected, and then press "POWER" button to turn on the monitor
	Unstable power voltage	Reconnect to power supply
	BNC or HDMI cable loose contact or not correctly connected	Check and correctly connect the BNC or HDMI cable
	The attached battery is no power	Change battery
	Using DIY power supply but the polarity is reversed	Refer to the provided power supply, reconnect the power.
Image or color abnormal	Bad contact of BNC or HDMI cable	Change cable
	Video signal has Interference	Remove the interference source(s)
	Improper adjustment of the color parameters	Adjust the "Recall profile" to "Default" under "System" submenu
	Distortion of the image	Reset the Aspect ratio
	Set to Red/Green/Blue only or Mono	Turn the Blue only/ Red Only/ Green Only/Mono off under R/G/B/Mono submenu
	Turn on the "Focus Assist" function	Turn off the "Focus Assist" function
	Turn on the "False Color" function	Turn off the "False Color" function
No audio output	Set to Mute	Turn off MUTE or revolve "MENU/ENTER" to adjust the volume
	Bad contact of signal cable	Change signal cable
	Wrong connection or bad contact of Audio cable	Connect to the correct input socket.

SWIT®