

SWIT®

SWIT Electronics Co., Ltd.

Model: S-1093H

9" Full HD Broadcast LCD Monitor

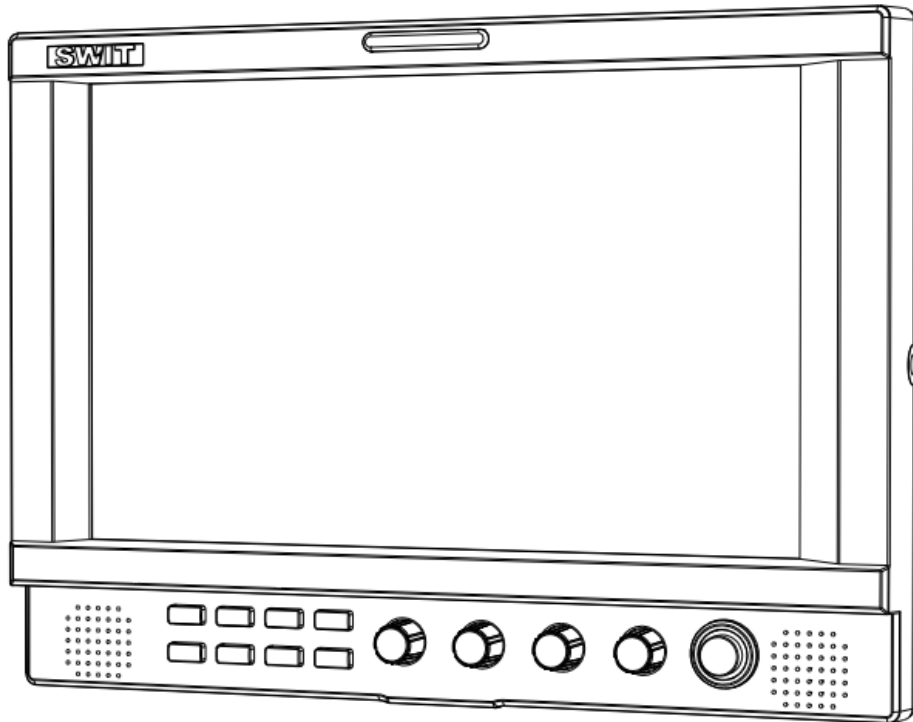

User Manual

Ver: A.2

Please read this User Manual
throughout before using.

Preface

1. All internal technologies of this product are protected, including device, software and trademark. Reproduction in whole or in part without written permission is prohibited.
2. All brands and trademarks of SWIT Electronics Co., Ltd. are protected and other relative trademarks in this user manual are the property of their respective owners.
3. Due to constant effort of product development, SWIT reserves the right to make changes and improvements to the product described in this manual without prior notice.
4. The warranty period of this product is 2 years, and does not cover the following:
 - (1) Physical damage to the surface of the products, including scratches, cracks or other damage to the LCD screen or other externally exposed parts;
 - (2) The LCD dot defects are not over three;
 - (3) Any damage caused by using third-party power adaptors;
 - (4) Any damage or breakdown caused by use, maintenance or storage not according to the user manual.
 - (5) The product is disassembled by anyone other than an authorized service center.
 - (6) Any damage or breakdown not caused by the product design, workmanship, or manufacturing quality, etc.

* Any sales personnel have no rights to provide additional warranty.
5. For any suggestions and requirements on this product, please contact us through phone, fax, Email, etc.

SWIT Electronics Co., Ltd.

Address: 10 Hengtong Road, Nanjing Economic and Technological Development Zone,
Nanjing 210038, P.R.China

Phone: +86-25-85805753

Fax: +86-25-85805296

Email: contact@swit.cc

Website: <http://www.swit.cc>

Maintenance

Warning

1. In order to reduce the risk of fire and electrical shock, do not lay this product in rain or damp places.
2. Please keep away from the strong magnetic field; it may cause the noise of the video and audio signals.

The power

1. Please use the power adapter provided or recommended by the manufacturer in order to avoid damage.
2. For a third party power adapter, please make sure the voltage range, supplied power, and polarity of power lead are fit.
3. Please disconnect the power cable under the following situations:
 - (A). If you do not operate this monitor for a period of time;
 - (B). If the power cable or power adaptor is damaged;
 - (C). If the monitor housing is broken.

The monitor

1. Please don't touch the screen with your fingers, which would probably deface the screen.
2. Please don't press the screen; the LCD is extremely exquisite and flimsy.
3. Please don't lay this product on unstable place.

Cleaning

1. Please clean the screen with dry and downy cloth or special LCD cleanser.
2. Please do not press hard when cleaning the screen.
3. Please do not use water or other chemical cleanser to clean the screen. The chemical may damage the LCD.

Contents

Preface.....	2
Maintenance	3
Contents.....	4
Packing list.....	4
Introduction	4
Installation Dimensions.....	5
Operation Instructions	6
Front Panel.....	6
OSD.....	7
Back Panel.....	9
Main Menu	10
Battery Plate	16
Specification.....	18
Trouble-Shooting	19

Packing list

Standard Package:

1. Sun hood
2. Cold shoe / Screw arm trestle
3. Power adaptor+ power cable
4. Battery plate(V-mount, Gold mount or DV battery plate)

Optional Purchase:

1. U shape desktop stand
2. D-tap to 4-pin XLR cable
3. Carrying case

Introduction

S-1093H adopts IPS LCD panel, with resolution 1920×1200 and wide viewing angle H170°/V170°. It supports 2 x 3GSDI (Level A/B) , 1 x HDMI, 1 x CVBS and 1 x analog audio input. It also supports 2 x 3GSDI, 1 x HDMI, 1 x CVBS and 1 x analog audio loop through output.

Features:

- Support multiple Aspect Ratio and scan modes
- Support multiple Marker selection (Marker, Safety Area)
- Support multiple functions user-defined (Source ID, function keys, GPI)
- Multiple power supply methods to meet different requirements
- TSL UMD (RS485) Tally, GPI control
- USB firmware upgrade
- Support 2K

Installation Dimension

The main body (in mm)

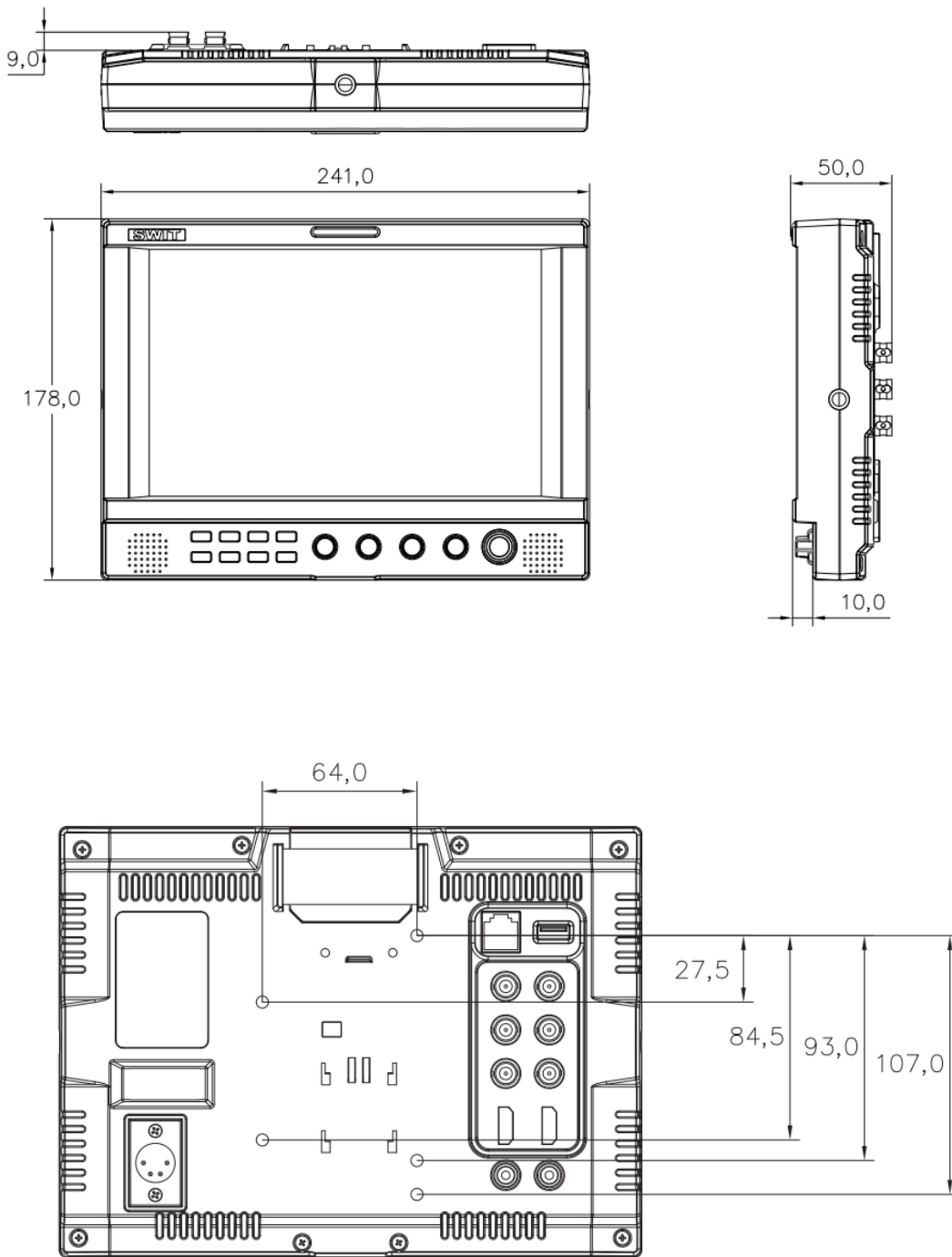

Operation Instructions

•Front Panel

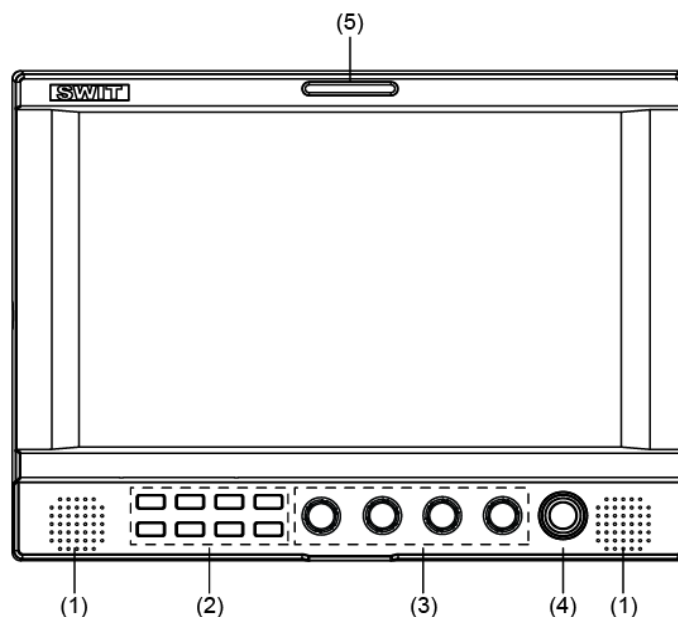

(1) Speaker: For SDI/HDMI embedded audio and analog audio monitoring. (Will not work if earphone is plugged in)

(2) Button



SOURCE: Press "SOURCE" to select SDI1, SDI2, HDMI, and CVBS signal input.

F1~F5: User definable function keys. Please see details in "4. Function key" under "Main Menu".

AUDIOBAR: Press "AUDIOBAR" to switch on/off audio bar.

DISPLAY: Press "DISPLAY" to turn on or turn off relevant status information, audio and video waveform.

When main menu is activated, press "DISPLAY" to quit menu.

(3) Rotary Knob

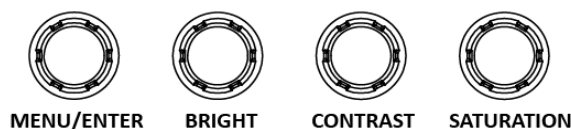

MENU/ENTER: When the menu is inactivated, presses "MENU/ENTE" to turn on the main menu;
Revolve "MENU/ENTER" to adjust settings or parameters, and press to apply;
When the menu is inactivated, revolve "MENU/ENTER" to adjust sound volume.

BRIGHT: 0-100 value adjustment and the default value is 50.

CONTRAST: 0-100 value adjustment and the default value is 50

SATURATION: 0-100 value adjustment and the default value is 50

(4) POWER: Power on/off

(5) TALLY Light: Red, Green and Yellow 3-color TALLY indicator

·OSD

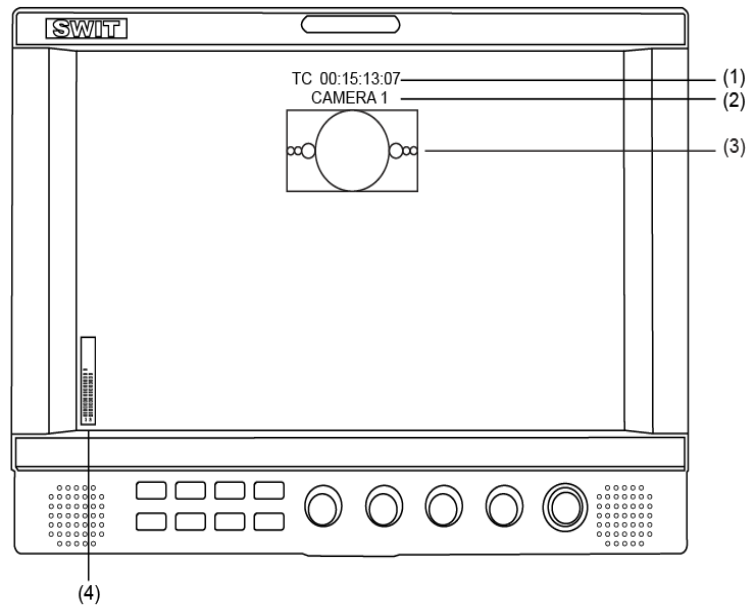

(1) Time code (SDI)

Under SDI input, it can display Time code. If no Time code information is detected, it will be displayed as "TC: UNLOCKED".

User can set function keys F1~F5 or GPI pins as "Time code" to turn on or off this function.

(2) UMD

Set up the UMD under 'UMD' submenu.

(3) AFD (SDI)

User can set function keys F1~F5 or GPI pins as "AFD" to turn on or off this function. If no relevant information is detected, it will be displayed as "AFD: UNLOCKED".

(4) Audio Bar

Monitor the audio information. User can set function keys F1~F5 or GPI pins as "Audio" to turn on or off this function.

The relevant parameters like position, audio channels and blending, etc can be changed under "Audio" submenu.

Introduction of audio and video functions

◆ 2-ch embedded audio meters

Under 3G/HD/SD SDI, HDMI and CVBS, it displays 2 channels embedded audio meters. The audio meter is green, and will turn yellow when audio exceeds -20dB, and turn red when audio exceeds -9dB.

◆ Audio alarm

If the embedded audio value is too low or no embedded audio, it will display "MUTE" or "UNLOCKED" in the audio bar.

◆ Time code (SDI)

Under SDI input, it can display the SMPTE time code (VITC1, VITC2 or LTC) on the top of the screen, which is used extensively for synchronization, and for logging and identifying material in recorded media. If no Time code information is detected, it will be displayed as "UNLOCKED".

◆ Internal Color Bar

Under SDI and HDMI input, it has 100% internal color bar which helps to analyze the monitor color and adjust the display parameter.

User can set function Keys F1~F5 or GPI pins as "color bar" to turn on or off this function.

◆ Peaking focus assist (red/blue switch)

The Peaking focus assist function is to mark the sharpest edges of the image with red or blue color under SDI and HDMI input, for users to check if the subjects are focused.

User can set function Keys F1~F5 or GPI pins as "Focus Assist" to turn on or off this function.

◆ Zebra stripes

Zebra Stripes are used to check if the image is over exposed or not by showing black and white lines on the monitor. It is considered over exposed when luminance value exceeds 90%.

User can set function Keys F1~F5 or GPI pins as "Zebra" to turn on or off this function.

◆ Freeze Frame

The freeze frame is to capture and display the current broadcast frame.

User can set function Keys F1~F5 or GPI pins as "Freeze Frame" to turn on or off this function.

◆ R/G/B/Mono

R/G/B/Mono is to display only the blue/red/green primary signal or the luminance signal only so as to monitor the image noise.

User can set function Keys F1~F5 or GPI pins as "R/G/B/Mono" to turn on or off this function.

◆ False Color

The false color is used to aid in the setting of camera exposure. Under false color mode, there's a color chart on the bottom of screen for reference. The color from the dark to the bright will be displayed as blue, cyan, green, yellow, orange and red in a consecutive way. User can set function Keys F1~F5 or GPI pins as "False color" to turn on or off this function.

◆ AFD (SDI)

It is the abbreviation of active format description. AFD is to display the SDI embedded AFD information graphically on the screen.

◆ H/V Delay (SDI)

Under SDI input, H/V Delay can be used to display line/field blanking signal, and to observe the horizontal and vertical synchronous signal.

◆ UMD

When using external control unit, it can display the video source ID and tally information on the screen.

◆ Image Flip

Horizontal, vertical, horizontal and vertical two-way image flip function.

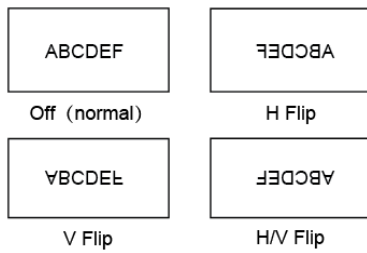

• **Back Panel**

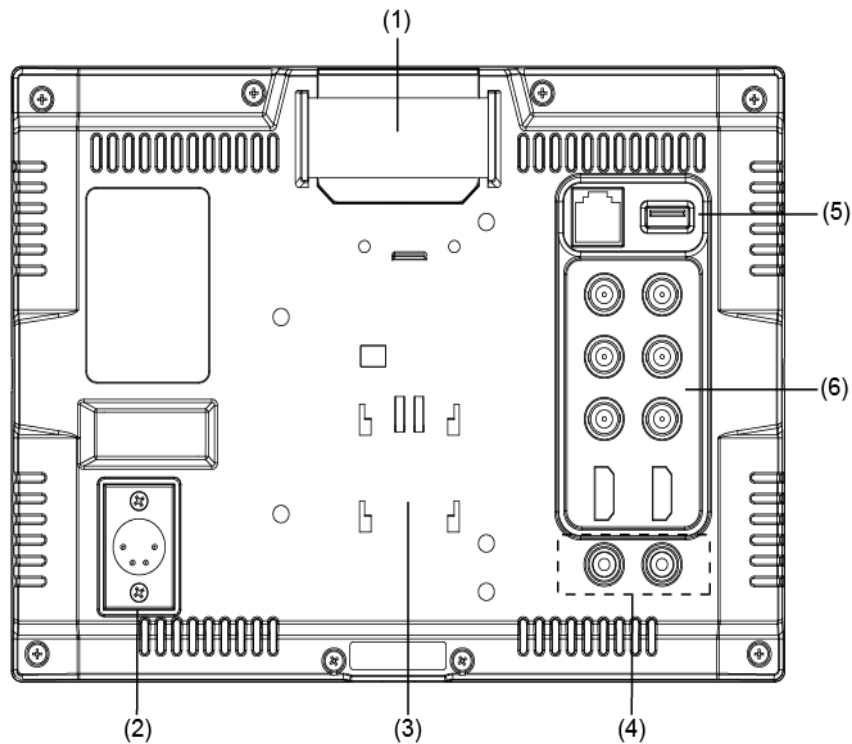

- (1) TALLY Light: Red, Green and Yellow 3-color TALLY indicator
- (2) DC 12V IN: Connect with DC12V 4-pin XLR power adapter, support 6.5V-24V voltage input (Pin 1: Negative, Pin 4: Positive)
- (3) Battery mount connector
Connect with SWIT S-7004 series quick release battery plate, and then mount corresponding V-mount or DV batteries. See details in “Optional Battery Plate”.
- (4) Audio Socket
AUDIO IN: 3.5mm analog audio input (CVBS)
AUDIO OUT: 3.5mm audio output, to monitor SDI embedded audio, HDMI and analog audio output
- (5) Multi-function Socket
GPI: TSL UMD&GPI control socket
USB Socket
- (6) Video Signal Interface

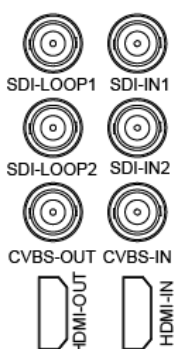

- SDI-IN1: SDI input (BNC connector)
- SDI-LOOP1: SDI loop through output from SDI-IN1 (BNC connector)
- SDI-IN2: SDI input (BNC connector)
- SDI-LOOP2: SDI loop through output from SDI-IN2 (BNC connector)
- CVBS-IN: CVBS input (BNC connector)
- CVBS-OUT: CVBS output (BNC connector)

HDMI-IN: HDMI input (HDMI-A connector)

HDMI-OUT: HDMI loop through output from HDMI-IN (HDMI-A connector)

Main Menu

S-1093H has OSD to adjust the parameters and settings, for example: Picture, color temp., function keys, etc.

1. Press "MENU/ENTER" button, the main menu will popup from the left top of the screen. The selected main menu highlights in yellow.

Main Menu	Status
Exit&Status >	HDMI XXX
Picture >	User Profile XX
Color Temp >	Color Temp XXXX
Function Key >	Scan Mode XXX
GPI >	Freeze Frame XXX
UMD >	Odd/Even Frame XXX
Marker >	F1 XXX
Audio >	F2 XXX
Vector >	F3 XXX
Waveform >	F4 XXX
Display >	F5 XXX
System >	System Version XXX
OSD >	
Key Inhibit >	

2. Revolve "MENU/ENTER" to select submenu, the selected submenu highlights in yellow, press "MENU/ENTER" to apply and enter into the selected submenu's items.
3. Revolve "MENU/ENTER" to select the item which needed to adjust, press "MENU/ENTER", the selected item and its parameters will be highlighted in yellow.

Main Menu	Marker
Exit&Status >	Exit
Picture >	Marker XX
Color Temp >	Marker Select 15:9
Function Key >	Safety Area XXX
GPI >	Fit Marker XXX
UMD >	Center Marker XXX
Marker >	Marker Color XXX
Audio >	Marker Outside XXX
Vector >	
Waveform >	
Display >	
System >	
OSD >	
Key Inhibit >	

4. Revolve "MENU/ENTER" to change the selected item's parameter, press "MENU/ENTER" to apply and save the settings.
5. Revolve "MENU/ENTER" to select "Exit", press "MENU/ENTER" to quit submenu. Select "Exit & Status" under the Main Menu and press to quit Main Menu.

Notice:

- * The items in gray can not be set up.
- * If there is no operation under the setted time, the menu will automatically save settings and quit.
- * If the key inhibit function is turned on, except key inhibit function, all other items are in grey. Please turn off the key inhibit function to adjust the items.

Submenu introduction (the default values are marked with underline)

1. Exit & Status

Displays the current status, the details are as down below:

Exit&Status	HDMI* ¹	1080p@50Hz
	User Profile	Factory
	Color Temp	6500K
	Scan Mode	Normal
	Freeze Frame	Off
	Odd/Even Frame	Off
	F1* ²	Time Code
	F2	Focus Assist
	F3	Zebra
	F4	Marker
	F5	Mute
	System Version	VXXX-XX

*1 Display the current video signal and format

*2 Display the current function keys setup

2. Picture

To adjust picture parameters.

Picture	Exit	
	Contrast	0-100, <u>50</u>
	Brightness	0-100, <u>50</u>
	Saturation	0-100, <u>50</u>
	Sharpness	0-100, <u>50</u>
	Hue	0-100, <u>50</u>
	Backlight	0-100, <u>60</u>

3. Color Temp

To select different color temperature or setup user-defined color parameters.

Color Temp	Exit	
	Gamma	2.2、 <u>2.4</u> 、2.6
	Color Temp	<u>6500K</u> 、5600K、9300K、User
	Red Gain	0-255, 128
	Green Gain	0-255, 128
	Blue Gain	0-255, 128
	Red Bias	0-255, 128
	Green Bias	0-255, 128
	Blue Bias	0-255, 128

* Only “Color Temp” is set to “User”, the Red/Blue/Green Gain or Red/Blue/Green Bias can be adjusted.

4. Function key

To define the F1~F5 function keys.

Function Key	Exit	
	F1* ¹	<u>Time Code</u>
	F2	<u>Focus Assist</u>
	F3	<u>Zebra</u>
	F4	<u>Marker</u>
	F5	<u>Mute</u>

*1 Function keys F1-F5 can be setted as the down below functions:

Time code, Zebra, Audio Bar, false Color, AFD, H/V Delay, R/G/B/Mono, Marker , Color Bar, UMD, Audio Alarm, Focus Assist , Aspect Ratio, Scan Mode, Zoom Mode, Mute, Freeze Frame, Image Flip,

CVBS,HDMI, SDI1,SDI2, color temp.

For example: Set F3 to “R/G/B/Mono” under “Function key” submenu. User can press F3 on the front panel to adjust the parameters of “R/G/B/Mono”, and the “R/G/B/Mono” will change and follow the sequence: Blue Only ’ Red Only ’ Green Only ’ Mono ’ Off.

5. GPI

User can set GPI pins1~4 to relevant functions to turn on or off this function.

GPI	Exit	
	GPI Control* ¹	<u>Off</u> , On
	1Pin * ²	<u>Red Tally</u>
	2Pin	<u>Green Tally</u>
	3Pin	<u>Audio Alarm</u>
	4Pin	<u>UMD</u>
	5Pin	Color Temp
	6Pin	Mute

*1 When “GPI control” is set to “On”, the monitor can be operated through external GPI control unit.

*2 The GPI pins can be setted to the down below functions:

Red Tally, Green Tally, Yellow Tally, Aspect Ratio, Scan Mode, Zoom Mode, Mute, Freeze Frame, Image Flip, Color Temp, Time Code, Zebra, Audio Bar, False Color, AFD, H/V Delay, R/G/B/Mono, Marker, Color Bar, UMD, Audio Alarm, Focus Assist.

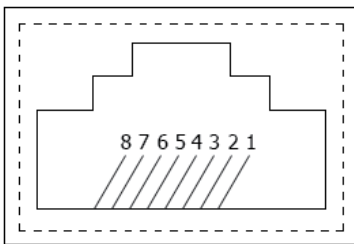

Pin	1	2	3	4
GPI	GPI_1	GPI_2	RXD+	GPI_3
Pin	5	6	7	8
GPI	GPI_4	RXD-	NC	GND

When connecting the GPI pin with ground, the setted function will be turned on, and goes out when disconnecting.

Example 1: Under “GPI ” submenu, set “GPI control” to “On”, set “2 Pin” to “Red Tally”, when the pin 2 of the external GPI control unit is connected with ground, the Tally light on the front panel will turn red. When disconnected, the tally light will turn off.

Example 2: Under “GPI ” submenu, set “GPI control” to “On”, set “3 Pin” to “Scan Mode”, when the pin 6 of the external GPI control unit is connected with ground, the Scan mode will change and follow the sequence: •Normal• ’ •Overscan• ’ •Native• .

6. UMD

Support “TSL UMD Protocol-V4.0” provided by Television System LTD

UMD	Exit	
	RS485 Address	<u>1</u> -126
	Position	<u>Top</u> , Bottom
	Display Type	<u>Source ID</u> , UMD
	Baud Rate	<u>38400</u> , 9600, 19200
	Parity	<u>Even</u> , None
	Serial Port	RS485
	Source ID	<u>CAMERA 1</u>

Setup Source ID:

Select "Source ID", revolve "MENU/ENTER" to select the letters and press "MENU/ENTER" to input. Max 8 letters are supported. Select "Exit" to quit and save settings, the source ID will be displayed on top or bottom of the screen.

UMD setup:

- (1) Connect the external control equipment with S-1093H;
- (2) Set "Display Type" to "UMD" under UMD submenu;
- (3) Make sure the "address", "Baud Rate", "Parity" the same;
- (4) Adjust the external control equipment and send UMD command, the UMD information will display as the right photo.

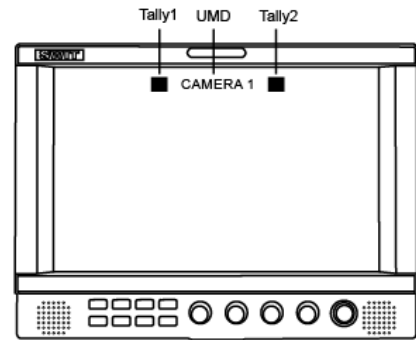

User can set the character and color of the UMD and the color of Tally1 and Tally2. Please see "5. GPI" to check the "RS485 pin sequence and definition."

7. Marker

Marker	Exit	
	Marker	<u>Off</u> , On
	Marker Select	Off, 4:3, 13:9, 14:9, 15:9, 16:9, <u>1.85:1</u> , 2.35:1
	Safety Area	Off, 80%, 85%, <u>90%</u> , 93%, 95%
	Fit Marker*1	<u>Off</u> , On
	Center Marker	Off, <u>On</u>
	Marker Color	<u>White</u> , Red, Green, Blue, Black, Gray
	Marker Outside	Off, <u>Gray</u> , Black

*1 When "Fit Marker" is "Off", the size of safety area is benchmarked against the actual display screen, accounting for 80% ~ 95% of actual display screen. When "Fit Marker" is "On", the size of safety area is benchmarked against the area inside the scales marker, accounting for 80% ~ 95% of the area inside the scales marker.

Example:

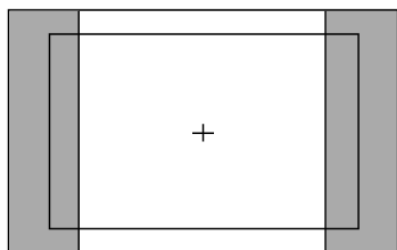
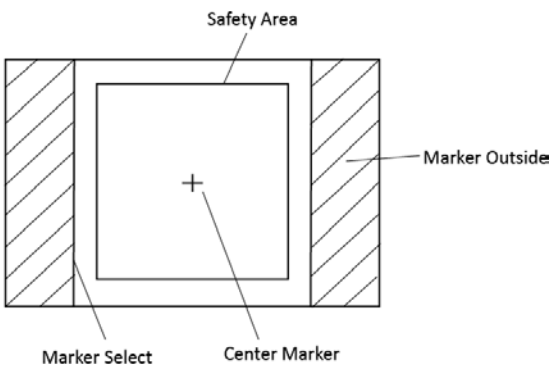

Aspect ratio: 4:3
 Safety Area: 85%
 Center Marker: On
 Fit Marker: Off

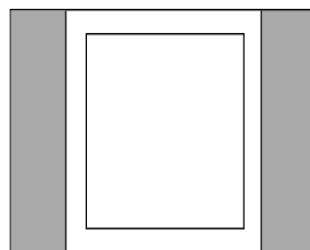

Aspect ratio: 4:3
 Safety Area: 85%
 Center Marker: Off
 Fit Marker: On

8. Audio

Audio	Exit	
	Audio Bar	<u>Off</u> , On
	Bar Frame *1	Off, <u>On</u>
	Bar Position	<u>Top Right</u> , Bottom Left, Bottom Right, Top Left
	Bar Blending	<u>Low</u> , Off, High
	Audio Alarm *2	<u>Off</u> , On
	Select Channel	Channel 1-2
	Left Channel *3	CH1-CH2, <u>CH1</u>
	Right Channel	CH1-CH2, <u>CH2</u>

*1 When “Bar Frame” is set to “Off”, only the audio meter will be displayed.

When “Bar Frame” is set to “On”, frame and real-time audio value will be displayed.

*2 When “Audio Alarm” is set to “On”, if no embedded audio is detected, the audio bar will display “UNLOCKED”. If the audio value is too low, the audio bar will display “MUTE”.

*3 Only under SDI I signal, channel1-2 can be selected.

In audio bar, the left channel audio value is marked with green and right channel audio value is marked with red.

9. Display

Display	Exit	
	Waveform	Off
	Audio Bar	<u>Off</u> , On
	Vector	Off
	Zebra	<u>Off</u> , On
	Focus Assist	<u>Off</u> , Blue, Red
	Time Code	<u>Off</u> , On
	Histogram	Off
	False Color	<u>Off</u> , On
	AFD	<u>Off</u> , On
	H/V Delay	<u>Off</u> , On
	R/G/B/Mono	<u>Off</u> , Blue Only, Red Only, Green Only, Mono
	Color Bar	<u>Off</u> , On
	Marker	<u>Off</u> , On
	UMD	<u>Off</u> , On

10. System

System	Exit	
	Aspect Ratio	<u>16:9</u> 、4:3、Auto
	Scan Mode	<u>Normal</u> 、OverScan、Native
	Zoom Mode	<u>Off</u> 、Zoom1、Zoom2
	Odd/Even Frame	Off
	Color Space	Auto
	Freeze Frame	<u>Off</u> 、On
	Flip Mode	<u>Off</u> 、H Flip、V Flip、H/V Flip
	Recall Profile	<u>Factory</u> 、User1、User2、User3
	Save Profile	<u>User1</u> 、User2、User3
	Source Scan *1	<u>On</u> 、Off
	Logo *2	<u>On</u> 、Off
	Green Mode	Black Backlight
	Idle Duration	2Hours
	Update Driver *3	<u>No</u> 、Yes
	Update Kernel *4	<u>No</u> 、Yes

***1 Source Scan**

When set to "ON", after turn on the monitor, the signal will be inspected and follow the sequence of •SDI1' SDI2' HDMI' CVBS•.

For example: if channel is selected to SDI2, SDI-IN2 has no input, and CVBS has input. When turn on the monitor, after automatic inspection, SDI2 has no recognized signal, and CVBS has recognized signal, then the input signal will be CVBS.

When set to "Off", source scan will not be supported.

***2 Logo**

When powered on, the screen will display SWIT logo.

***3、*4 Update Driver/ Kernel**

(1) Power the monitor, insert the USB equipment with update software into the USB socket.

(2) Press "MENU" to open the main menu, and revolve to "system" submenu,

(3) Set "Update Driver" and "Update Kernel" to "Yes" under "System" Submenu, press "MENU/ENTER" to apply.

(4) During the update procedure, please do not power off to make sure the software writing has been successfully completed.

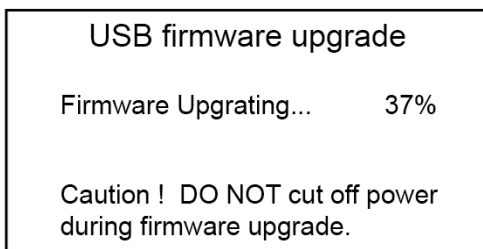

(5) After upgrading, the monitor will auto restart.

11.OSD

OSD	Exit	
	OSD Language	<u>English</u> 、Chinese
	OSD Blending	<u>Low</u> 、Medium、High、Off
	OSD Duration	<u>10Sec</u> 、15Sec、30Sec、60Sec
	OSD Zoom	Off、 <u>On</u>
	Key Led Brightness	Low
	Tally-R Brightness	<u>High</u> 、Low、Medium
	Tally-G Brightness	<u>High</u> 、Low、Medium

12. Key Inhibit

Key Inhibit	Exit	
	Key Inhibit	<u>Off</u> 、On

If the “Key Inhibit” is “On”, there is no response when all the buttons except “MENU/ENTER” are pressed, the screen will be displayed as “Key Inhibit”.

User can set “Key Inhibit” under “key Inhibit” submenu to “Off” to recover the functions of all buttons.

Optional Battery Plate

1. Battery Mount choice

S-1093H monitor can use V-mount, Gold mount and various DV batteries by connecting with SWIT S-7004 series battery plates. There're following types of S-7004 for choice:

Model	Compatible battery type	Recommended SWIT battery
S-7004F	SONY L series NP-F770/970	S-8972, S-8970, S-8770
S-7004U	SONY BP-U series U60/30	S-8U63
S-7004D	Panasonic CGA-D54/D28 and VW-VBD58	S-8D62, S-8D58
S-7004B	Panasonic VW-VBG6	S-8BG6
S-7004J	JVC BN-V428U	S-8428
S-7004V	JVC BN-VF823	S-8823
S-7004I	JVC SSL-JVC50	S-8I50
S-7004C	Canon BP series BP-930/945/970G	S-8945, S-8845
S-7004E	Canon DSLR, LP-E6	S-8PE6
S-7004S	SONY V-mount batteries	S-8080S, S-8110S, S-8160S.etc
S-7004A	Anton Bauer Gold mount batteries	S-8080A, S-8110A, S-8160A.etc

2. Installation of S-7004F/D/J/C/U/E/B/V/I snap-on type DV battery plate:

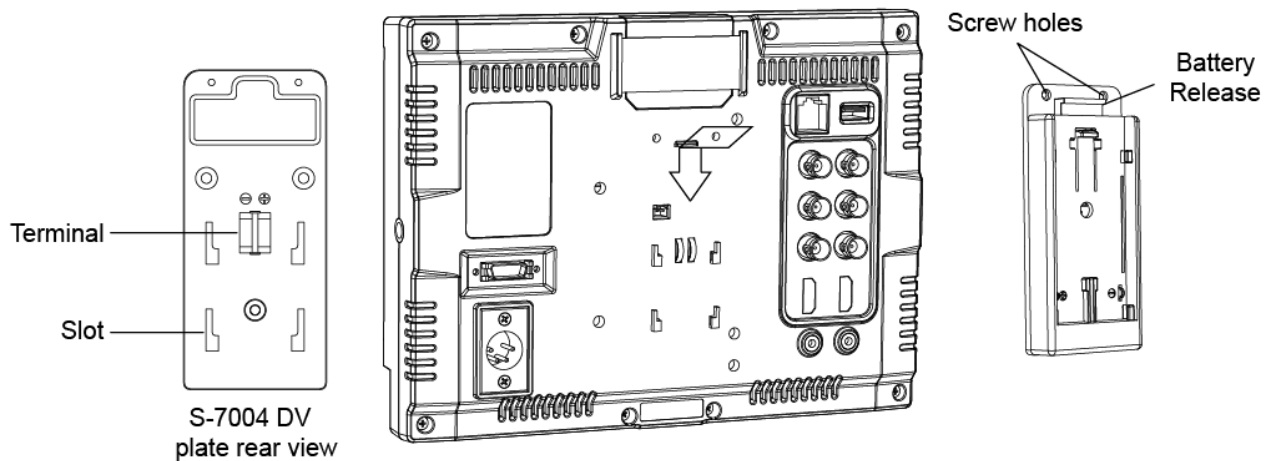

S-7004F/D/J/C/U/E/B/V/I DV plate is snap-on type, quick release and interchangeable. Please follow the instructions to install:

- (1) Please make sure the power terminals are clean and in well condition before use.
- (2) Align the S-7004 DV plates slots to the bolts of the monitor rear panel, and press tightly in.
- (3) Fix the S-7004 DV plates by provided screws on the top side.
- (4) Mount the corresponding battery to S-7004 DV plate to power the monitor.
- (5) To release the battery, press the battery release button to take out the battery

• Installation of S-7004A/S Gold mount / V-mount battery plate

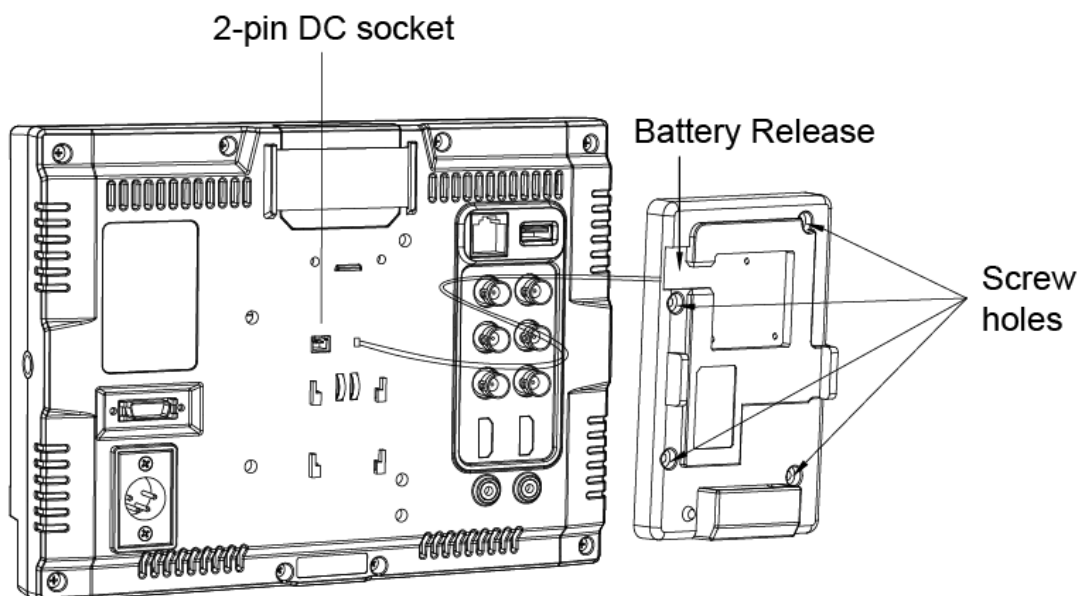

To use Gold mount or V-mount battery, please install the S-7004A/S plate as following instructions:

- (1) Please make sure the power terminals are clean and in well condition before use.
- (2) Connect the wire of S-7004A/S to the 2-pin DC socket.
- (3) Align the S-7004A/S screw holes to the bolts of the monitor rear panel.
(S-7004A Gold mount plate need a spare bedding between the monitor and plate)
- (4) Fix the S-7004A/S mount by provided screws.
- (5) Mount Gold mount / V-mount battery to S-7004A/S to power the monitor.
- (6) Press the battery release to take down the battery

Specification

LCD Performance		
Size	9inch	
Display area	191.5×119.7 mm	
Resolution	1920×RGB×1200	
Color	8 bit	
Aspect ratio	16:9 / 4:3	
Brightness	450 cd / m ²	
Contrast	1000:1	
Viewing Angle	Horizontal: 170°Vertical: 170°	
Input/output		
Input	BNC×2	3G/HD/SD-SDI ×2
	BNC×1	CVBS input
	HDMI×1	HDMI input
	GPI×1	UMD, GPI×1
	USB×1	
	3.5mm×1	analog audio input
Output	BNC×2	3G/HD/SD-SDI loop through output
	BNC×1	CVBS loop through output
	HDMI×1	HDMI loop through output
	3.5mm×1	SDI/HDMI/analog audio output
Video Format		
CVBS	NTSC / PAL	
HDMI	480i / 576i / 480p / 576p	
	1080i (60 / 59.94 / 50)	
	720p (60 / 59.94 / 50)	
	1080p (60 / 59.94 / 50 / 30 / 29.97 / 25 / 24 / 23.98)	
	1080psf (30 / 29.97 / 25 / 24 / 23.98)	
SDI	SMPTE-425M-A/B	1080p (60 / 59.94 / 50)
	SMPTE-274M	1080i (60 / 59.94 / 50)
		1080p (30 / 29.97 / 25 / 24 / 23.98)
	SMPTE-RP211	1080psf (30 / 29.97 / 25 / 24 / 23.98)
	SMPTE-296M	720p (60 / 59.94 / 50)
	SMPTE-125M	480i (59.94)
	ITU-R BT.656	576i (50)
SMPTE-2048-2	2048×1080p (23.98 / 24 / 25 / 29.97 / 30 / 50 / 59.94 / 60) 2048×1080i (50 / 59.94 / 60)	
General		
Input voltage	DC 6.5V-24V	
Power consumption	18W	
Working temperature	0℃~+40℃	
Working humidity	10%~90%	
Storage temperature	- 15℃~ + 60℃	
Storage humidity	10%~90%	
Dimensions	241×178×50mm	
Net weight (main body)	960g	

Trouble-shooting

Symptom	Possible Causes	Solution
No display	The power is not turned on	Please check if the power is connected, and then press "POWER" button to turn on the monitor
	Unstable power voltage	Reconnect to power supply
	BNC or HDMI cable loose contact or not correctly connected	Check and correctly connect the BNC or HDMI cable
	The attached battery is no power	Change battery
	Using DIY power supply but the polarity is reversed	Refer to the provided power supply, reconnect the power.
Image or color abnormal	Bad contact of BNC or HDMI cable	Change cable
	Video signal has Interference	Remove the interference source(s)
	Improper adjustment of the color parameters	Adjust the "Recall profile" to "Default" under "System" submenu
	Distortion of the image	Reset the Aspect ratio
	Set to Red/Green/Blue only or Mono	Turn the Blue only/ Red Only/ Green Only/Mono off under R/G/B/Mono submenu
	Turn on the "Focus Assist" function	Turn off the "Focus Assist" function
	Turn on the "False Color" function	Turn off the "False Color" function
No audio output	Set to Mute	Turn off MUTE or revolve "MENU/ENTER" to adjust the volume
	Bad contact of signal cable	Change signal cable
	Wrong connection or bad contact of Audio cable	Connect to the correct input socket.

SWIT®