

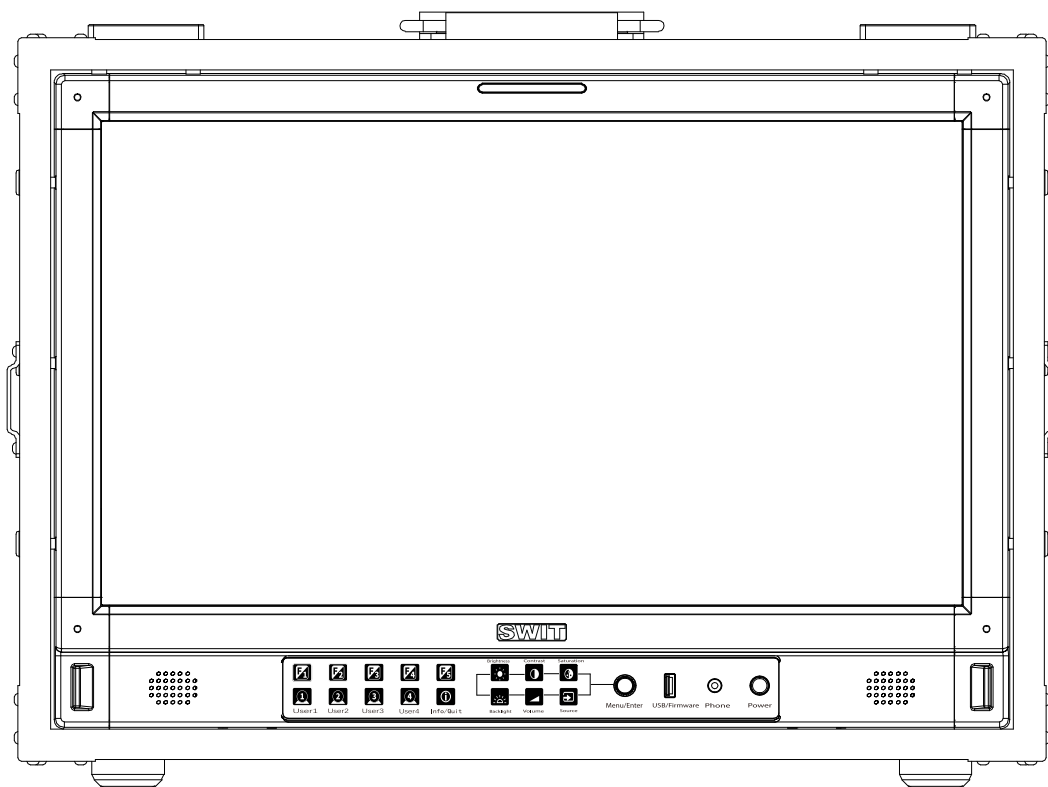

SWIT ELECTRONICS CO., LTD.

4K input FHD Broadcast Monitor

Model: FM-215HDR



User Manual

Please read this user manual throughout before using

Ver:B

Declaration

Any internal technology (including hardware equipment, software design and product trademark) of the product shall be protected by law, and any infringement of intellectual property rights of the product shall be investigated for legal liability.

All the brand and trademark in this product are protected by law, all other company's brand and trademark in this product are protected by their owner's law.

In order to better service majority users, SWIT products will keep improving and developing, SWIT keep the right to revise and improve this user manual without previous notice.

The warranty period of this product are two years, the following condition are not covered by the warranty:

- (1) The appearance and the LCD panel are damaged by man-made out force;
- (2) The amount of defective pixels are under three;
- (3) Damage the product by using incompatible power adaptor;
- (4) Damage the product due to violation operation;
- (5) Disassemble the product when using;
- (6) Other faults or damages not caused by design, technology, manufacture and quality.

* Any sales person have no right to provide extra warranty beyond these terms.

If you have any advises or requirements about our products during using, please feel free to contact with us via phone or E-mail.

- * This instruction manual applies to FM field monitors and the schematic is based on the exterior view of the FM-215HDR as an example. Any differences in specifications and appearance are explained in additional text in this manual.

SWIT Electronics Co., Ltd.

Address: 10 Hengtong Road, Nanjing Economic and Technological Development Zone,
Nanjing 210038, P.R.China

Phone: +86-25-85805753

Fax: +86-25-85805296

Email: contact@swit.cc

<http://www.swit.cc>

Maintaince percautions

Warning

1. To reduce the dangerous of fire or electric shock,do not expose the monitor in raining or wet place.
2. The monitor will create noise when using near high-intensity magnetic field.

Precautions for power supply

1. Please use the special power adapter specified by the original factory to avoid damage to the product.
2. If other DC power supply is used, ensure that the voltage range, power supply and polarity of the power supply meet the requirements.
3. In the following cases, please unplug the power cord and external battery of the product:
 - (A) If you have not used the product for A long period of time.
 - (B) If the power cord or power plug/socket is damaged.
 - (C) If the product is hit or dropped so that the shell is damaged.

Precautions for product use

1. Please do not touch the screen surface directly with your fingers to avoid damage to the screen, and the oil on the skin will be difficult to remove if left on the screen.
2. Please do not put pressure on the LCD screen, LCD screen is very delicate and fragile.
3. Do not place the product in an unstable place, as the product may be seriously damaged due to falling.

Precautions for product cleaning

1. Clean LCD screen, please use dry soft fabric with fluff and special liquid crystal cleaning agent, to remove dust and stains on the screen.
2. Do not pressure when wiping the LCD screen surface.
3. Please do not use water and other chemical cleaners to wipe the LCD screen surface, chemical agents may damage the LCD screen surface.

Content

Declaration	2
Maintaince percautions	3
Content	4
Packing list	5
Introduction	5
Operation Instructions	6
Front panel	6
Back Panel	8
Flight Case	9
OSD	9
Menu Configuration	12
1. Exit & Status - Exit the main menu and display the current status of the monitor.	12
2. Input—Set the color of input video	13
3. Image setting—Setting for the picture preference	13
4. Color management—Setting about video colors	14
5. Scanning—Setting for picture scan, zoom, etc.	15
6. Control—Setting for TALLY, UMD, IP control to the monitor.....	16
7. Assist-Setting for Vector scope and Histogram patterns.	18
8. De-embed—Setting for video/audio analysis functions.	20
9. Auto calibration	21
10. System-User profile saving,firmware update.	23
11. Multiview setting	26
Appearance and Size	27
Specification	28
Supported standards: Signals of the following standards can be displayed on the monitor	29
Common Problems and Solutions	30

Packing list

No.	Standard accessories	Quantities
1	Monitor	x 1
2	Aluminium flying case	x 1
3	Battery plate (V-mount & Gold-mount)	x 1
4	Power cable	x 1

Introduction

This series of monitor adopts full HD QLED screen, the resolution is up to 1920x1080, H178°/V178° ultra-wide viewing angle, 1000:1 contrast ratio, support 1 channel 12G/6G/3G/HD/SD-SDI input and output, 1 channel HDMI® 2.0 4K@60 input, and 3 channels 3G/HD /SD-SDI input and 1 channel 3G/HD/SD-SDI output, quad-link 4xSDI SQD /2SI 4Kp60/p50 inputs, 4-channel or 2-channel simultaneous picture display with headphone and speaker outputs .

Features:

- 21.5" 1920X1080 Full HD QLED screen.
- 1000nits high brightness backlight HDR monitor.
- 97% DCI-P3 wide color gamut ratio.
- 4K/UHD interface (1x12G-SDI in/out, 1x HDMI® 2.0 4K@60 input).
- 12GSDI, HDMI® Mixed Quad, Dual PBP and PIP Picture-in-Picture monitoring.
- 12GSDI, HDMI® dual-screen PBP vertical monitoring.
- Simultaneous display of HDR/SDR in multi-color gamut for one signal.
- Read Payload ID to automatically set quantisation, dynamic contrast, color gamut, etc.
- 18bit high precision internal signal processing.
- Zero audio/video delay (0.01 frame).
- Built-in DelogSDR/HDR table for multiple cameras.
- 16-channel audio de-embedded sound column display, optional 2-channel output.
- Lissajous, 5.1 stereo phase map.
- Support waveform selection display Y/Cb/Cr/R/G/B /RGB and single line selection mode.
- Vector scope, R/G/B/Y histogram, bi-color focus assist.
- 3DLUT accurate color correction, Fully automatic color correction, no computer required.
- User 3DLUT uploaded via USB.
- UMD dynamic source name and soft TALLY display (TSL 3.1/4.0), GPI control interface.
- Composition ratio auxiliary line:4:3/13:9/14:9/15:9/16:9/1.85:1/2.35:1/2:1/2.39:1/Custom 1/Custom 2.
- Support USB firmware upgrade and import Log file.(USB file system supports FAT 32 format only).
- IP Webserver Web Control.
- Support ECO mode.
- Support 17×17×17 or 33×33×33 User LUT import/unload.
- Anamorphic desqueeze: 1.33X,1.5X,1.66X,1.8X,2X,1.33X mag,1.5X mag,1.66X mag mag,1.8X mag,2X mag.
- Support F1~F5 function keys to switch channel.

Operation Instructions

Front panel

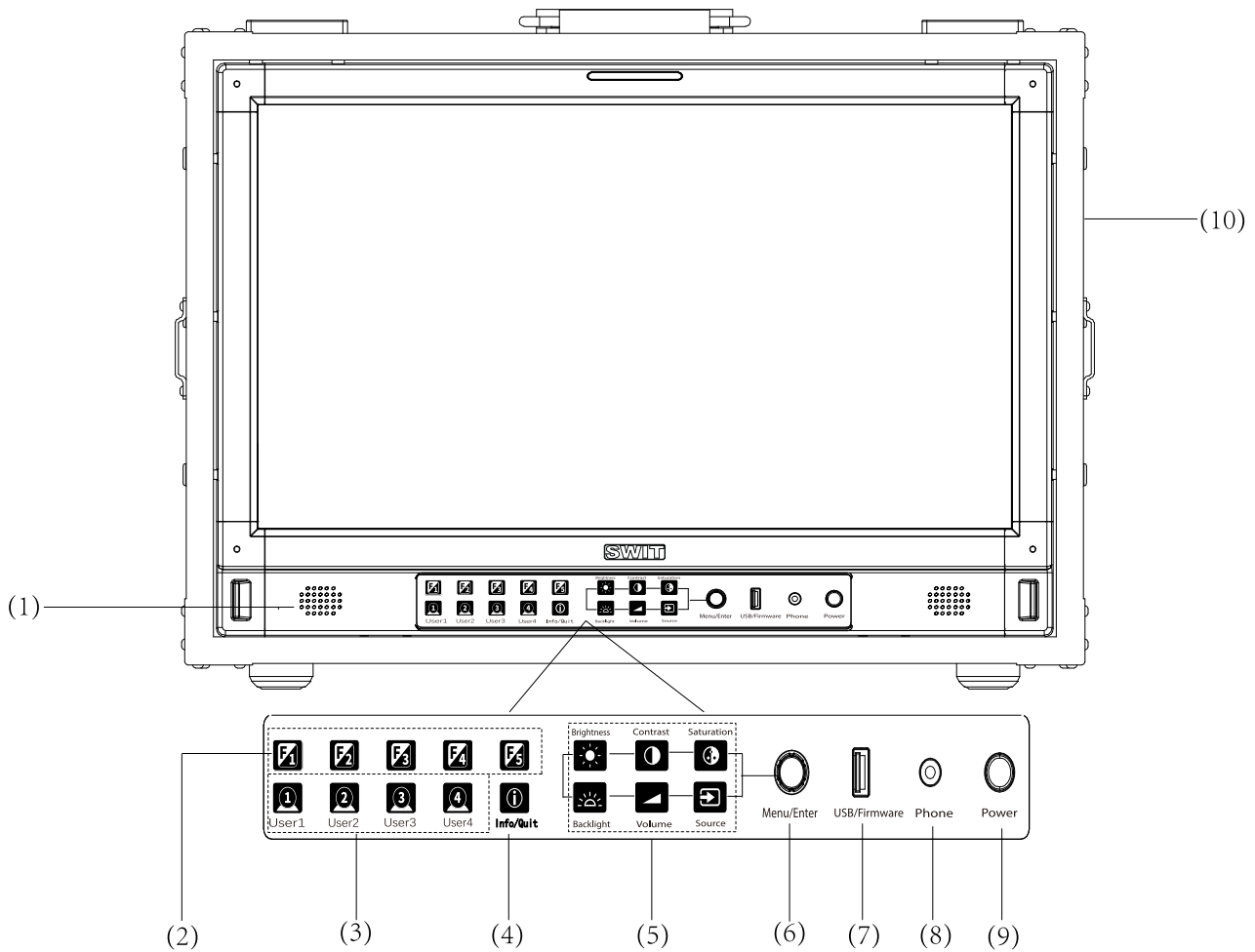

- (1) **Speaker:** For SDI/ HDMI® embedded audio. (Will not work if earphone is plugged in)
- (2) **F1~F5 function keys:** customised shortcut function keys, users can set the shortcut keys to different functions and channels according to their needs.
- (3) **User1~User4:** U1~User shortcut key, which can be used to quickly enter the set user mode. Long press to save user settings. Please see details in “10. System”
- (4) **Info/Quit:** Display setting item. Press " Info/Quit " button to display or turn off relevant status information and audio and video analysis function graph. When opening the menu, press " Info/Quit " to exit the menu with one click

(5)

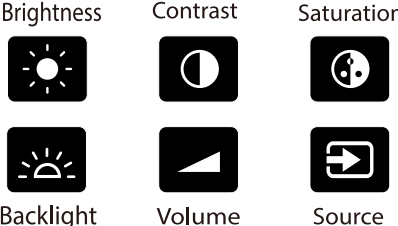
 <p>Brightness Contrast Saturation</p> <p>Backlight Volume Source</p>	Brightness: Adjust the brightness. -100~100 adjustable, default value is 0.									
	Contrast: Adjust contrast. -100~100 adjustable, default value is 0.									
	Saturation: Adjust saturation. -100~100 adjustable, default value is 0.									
	Backlight: Adjust the backlight. 0~100 adjustable, default value is 16.									
	Volume: Adjust the volume. 0~100 adjustable, default value is 36.									
<p>Press Brightness, Contrast, Saturation, Backlight, Volume five shortcut keys confirm to select this option, and rotate Menu to adjust the corresponding item value directly. Press the button and automatically cancel the selection without operation within five seconds, and the button light will be off, long press to restore default values; Adjust the volume. 0~100 adjustable, the default value is 36. Long press the volume button to mute.</p>										
<table border="1"><tr><td>Source</td></tr><tr><td>SDI 1</td></tr><tr><td>SDI 2</td></tr><tr><td>SDI 3</td></tr><tr><td>SDI 4</td></tr><tr><td>4xSDI SQD</td></tr><tr><td>4xSDI 2SI</td></tr><tr><td>HDMI®</td></tr><tr><td>Multiview</td></tr></table>	Source	SDI 1	SDI 2	SDI 3	SDI 4	4xSDI SQD	4xSDI 2SI	HDMI®	Multiview	<p>Source: Select the input source signal format.</p> <p>4xSDI SQD: Supports quad-link 4Kp60/p50 inputs</p> <p>4xSDI 2SI: Supports quad-link 4Kp60/p50 inputs</p>
Source										
SDI 1										
SDI 2										
SDI 3										
SDI 4										
4xSDI SQD										
4xSDI 2SI										
HDMI®										
Multiview										

- (6) **Menu/Enter:** When no Menu is displayed, press the button directly to open the Main Menu; Rotate the knob to select different settings or adjust parameter values, press the knob to set;
- (7) **LUT/Firmware:** Update firmware or import LUT files, Auto Calibration;
- (8) **PHONE:** 3.5mm headphone jack is used to monitor the embedded audio signals of SDI and HDMI®;
- (9) **Power:** Power switch;
- (10) **Aluminium alloy flight case:** to hold the monito.

Back Panel

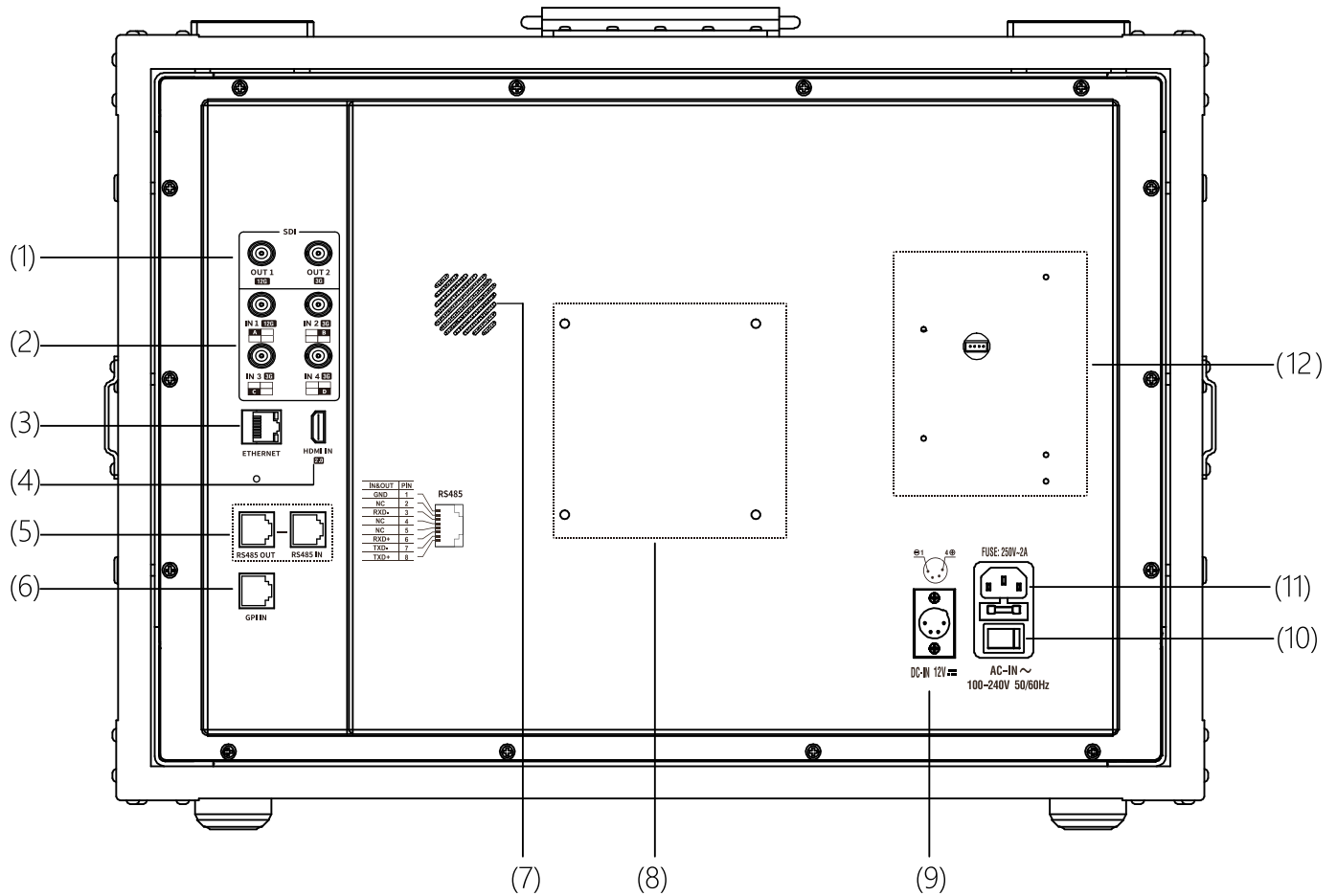

- (1) **SDI1 OUT:** 12G/6G/3G/HD/SD-SDI
SDI2 OUT: 3G/HD/SD-SDI
- (2) **SDI1 IN:** 12G/6G/3G/HD/SD-SDI
SDI2~4 IN: 3G/HD/SD-SDI
- (3) **ETHERNET**(Network interface): 1000M high-speed RJ45 Ethernet port, for web external control
- (4) **HDMI® 2.0 4K@60 in:** Will not display HDCP protected content
- (5) **RS485:** TSL UMD control port
- (6) **GPI:** GPI control port
- (7) **Fan**
- (8) **VESA bracket mounting area**
- (9) **DC IN:** 12V~17V
- (10) **AC switch:** turns AC power on or off
- (11) **AC IN:** 100V~240V
- (12) **Battery grommet mounting area**

Flight Case

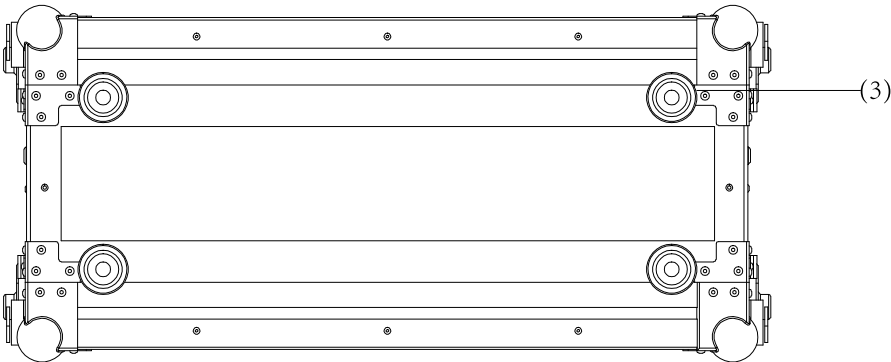
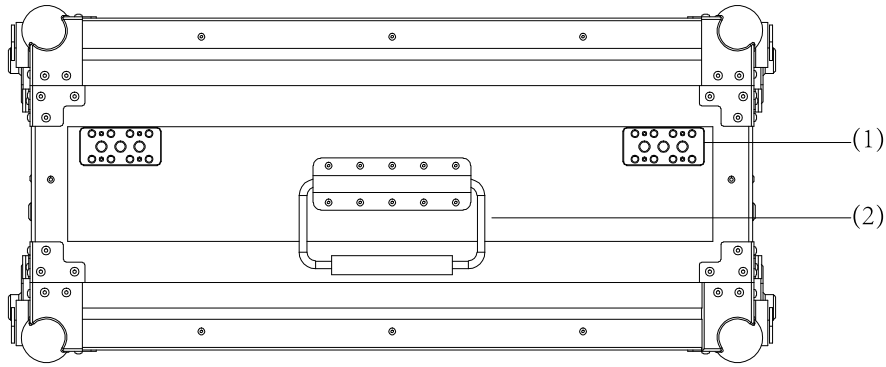

- (1) Flight case adapter plate:
can be used to secure other
equipment (e.g., PTZ, wireless
transmission equipment, etc.)
- (2) Flight case handle
- (3) Rubber cushion for luggage base

OSD

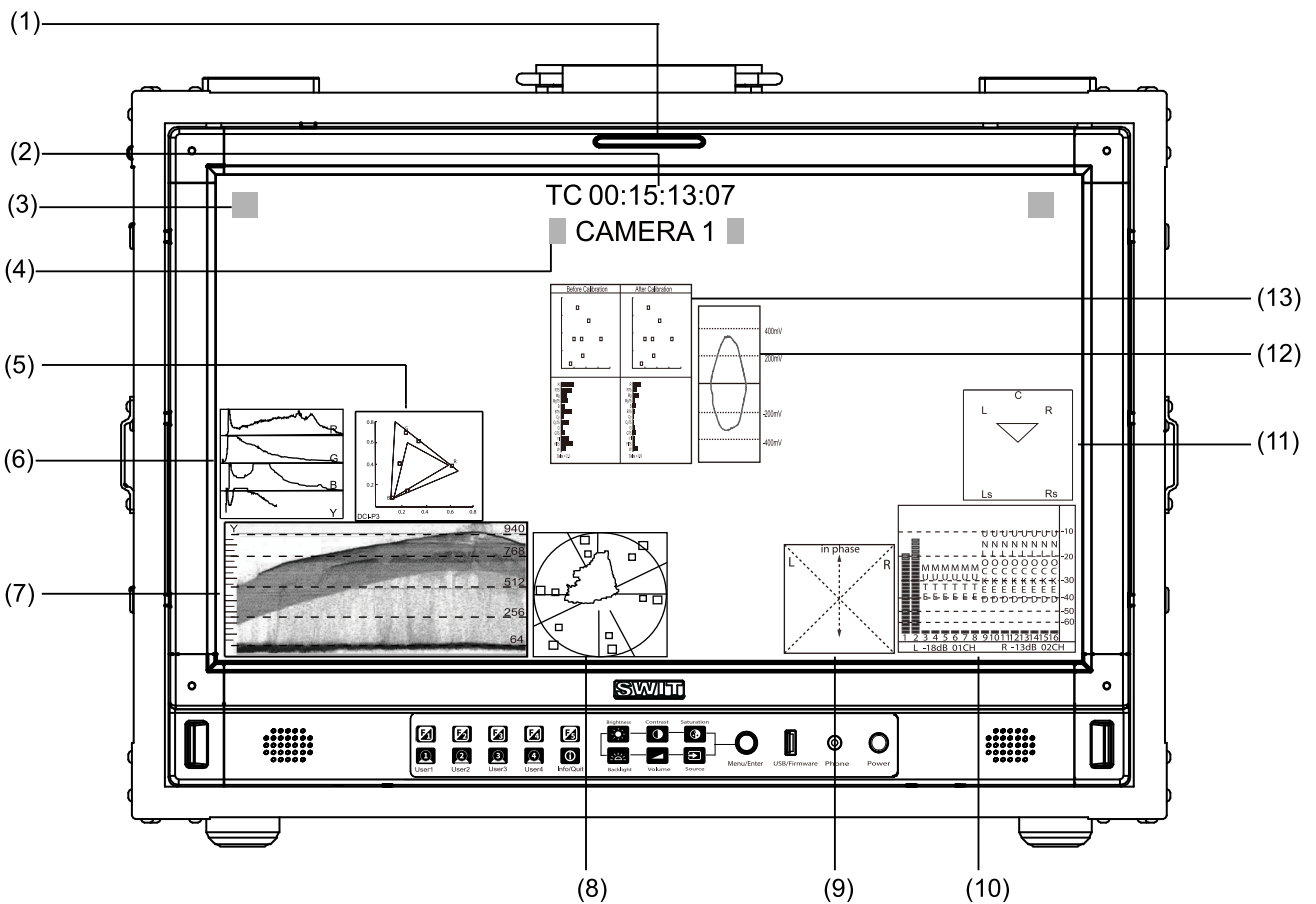

(1) TALLY Light

TALLY Light Controlled by GPI

(2) Time Code(SDI)

Under SDI input, the monitor can display Time code information (LTC, VITC1&2). If no Time code info is detected, it will display "TC UNLOCKED". User can set function keys F1~F5 or GPI pins as "Time Code" to turn on or off this function.

(3) On screen TALLY

Control of the display signal via GPI

(4) Source ID/UMD

Display /UMD (TSL3.1/4.0) , user can set in the UMD menu

(5) color gamut chart

Used to monitor the color fullness and fineness of the image, open the gamut chart to display the current video gamut, users can set the "Main Menu" - "color Management" - "Gamut".
Current color gamut.

(6) Histogram

The horizontal axis of the histogram indicates the brightness of the image, from left to right indicates the increase of brightness, the left side represents the darker area, the right side is the brighter area, the vertical axis of the histogram indicates the distribution of the number of pixels, the higher the vertical coordinate, the higher the brightness density.

The vertical axis of the histogram represents the distribution of the number of pixels, the higher the vertical coordinate, the higher the luminance density, users can set the front panel shortcut keys (F1~F5) or GPI pins to the "Histogram" function, to turn on/off this function.

(7) Waveform

Used to display multiple signals sampled at the same rate, users can set the front panel shortcut keys (F1~F5) or GPI pins to the " Waveform " function to turn on or off the Waveform graph and select different types of Waveform graphs; the parameters of the Waveform graph, such as the position, transparency, color, etc. are set in the " Waveform Setting" submenu. Waveform parameters, such as position, transparency, color, etc., can be set in the " Waveform Setting" submenu.

(8) Vectors

Used to monitor the color, shape, outline, size and position of the image, etc. Users can set the front panel shortcut keys (F1 to F5) or GPI pins to the "Vector Graphics" function to turn on/off this function, and the display position, color, transparency and other related parameters of the vector graphics are set in the "Vector Graphics Settings" submenu.

(9) Lissajous

Used to monitor the audio frequency analysis and phase amplitude difference determination, the user can set the front panel shortcut keys (F1~F5) to "Lissajous" function, open/close this function.

(10) Audio Meter

Used for monitoring audio information, users can set the front panel shortcut keys (F1~F5) or GPI pins as the function of "Audio Meter" to turn on/off this function, the display position of the audio meter, the number of displayed channels, transparency and other related parameters are set in the Audio Settings sub-menu.

(11) Surround Phase

Monitor the sound source location of the full-space stereo sense of knowledge, Surround Phase default 5.1, the default 7, 8 channels, the user can be in the menu "data de-embedding" - "left / right channel", set the desired sound channels

(12) Eye pattern

Used to monitor the strength of the SDI signal quality, the larger the eye chart image, the stronger the signal quality.

(13) color checklist

After auto calibration, the gamut value and color difference (ΔE) before and after calibration will be popped up. "Auto calibration"- "Measurement" pops up the gamut value and color difference (ΔE) of the last calibration and the current measurement.

Button operation

1. Press the "Menu/Enter" knob, the menu pops up in the upper left corner of the screen, and the currently selected menu is highlighted in yellow.
2. Rotate the "Menu/Enter" knob to select all kinds of sub-menu, the corresponding item is highlighted in yellow, press the "Menu/Enter" key, the sub-menu is selected and enter the parameter setting sub-menu.
3. Rotate the "Menu/Enter" knob to select the item to be adjusted, press the "Menu/Enter" knob, the adjustment items and parameters are highlighted in yellow.
4. rotate the "Menu/Enter" knob to adjust the parameters, complete the settings, click "Menu/Enter" to save the settings.
5. Rotate "Menu/Enter" to select "Exit", click "Menu/Enter" knob to exit the sub-menu, select "Exit & Status" in the main menu. Select "Exit & Status" in the main menu, click the "Menu/Enter" knob to exit the main menu.

Note

1. Items displayed in grey cannot be set;
2. If there is no operation within the set time, the menu will automatically save the settings and exit.
3. If the key lock function has been turned on, all items except "System Setting" will be displayed in grey, if you want to adjust any item, please set the key lock function to "Off" first.

Menu Configuration

Menu configuration introduces the main menu and the sub-menu, marked * menu items will be given in the list after a more detailed description of the menu or the operation of the explanation

Exit & Status - Exit the main menu and display the current status of the monitor.

Main Menu		Status
Exit&Status		Format XX —(1)
Input	>	Source XX —(2)
Picture	>	Color Temp XX —(3)
Color Management	>	F1 XXX —(4)
Scanning	>	F2 XXX
Control	>	F3 XXX
Assist	>	F4 XXX
De-embed	>	F5 XXX
Auto Calibration	>	Profile Type XX —(5)
System	>	Version XX —(6)
Multiview Setting	>	

Press "Menu/Enter" key, the main menu pops up in the upper left corner of the screen, and the main menu shows the current working status of the monitor.

(1) Standard

Display the standard of the current input signal; if there is no recognisable signal input, "No Signal" will be displayed. If you select Multi-screen for the current channel, and select 4-screen, 2-screen or Picture-in-Picture for the Multi-screen type, the standard will display the input signal standard of the screen 1/2/3/4 or screen 1/2 channel respectively.

(2) Input source

Displays the currently selected channel.

(3) color Temperature

Displays the currently set color temperature mode

(4) Function key 1~Function key 5

Displays the currently set function value of the function key

(5) Model

Displays the current monitor model

(6) Version

Displays the current software version number

2. Input—Set the color of input video

Menu Item	Menu description	Value
Input Range* ¹	Set the input range of input video	Full 0-1023、SDI Full 4-1019、Limited 64-940、64-1023
Red Gain	Adjust Red Gain	-100 ~ +100
Green Gain	Adjust Green Gain	-100 ~ +100
Blue Gain	Adjust Blue Gain	-100 ~ +100
Red Bias	Adjust Red Bias	-100 ~ +100
Green Bias	Adjust Green Bias	-100 ~ +100
Blue Bias	Adjust Blue Bias	-100 ~ +100
Reset	Reset the gain and bias values of the settings	/

*1 Input Range: Sets the quantization range of the video to suit the input video signal.
The default video quantization range is Limited 64-940 for the broadcast application

3. Image setting*¹—Setting for the picture preference

Menu item	Menu description	Value
Contrast	Adjust contrast	-100 ~ +100
Brightness	Adjust brightness	-100 ~ +100
Saturation	Adjust saturation	-100 ~ +100
Sharpness	Adjust sharpness	0 ~ +100
Backlight	Adjust backlight	0 ~ +100

*1 Image Settings

The image settings for contrast, brightness, saturation and backlight can be quickly adjusted using the front panel shortcut keys.

4. Color management—Setting about video colors

Menu item	Menu Description	Value	
Color gamut *1	Set gamut values	LCD Native,DCI-P3,Rec.709,Rec.2020	
Gamma*2	Set gamma values	1.0,1.8,2.2,2.4,2.6,PQ1000,HLG1000,S-Log3	
User Lut*3	Load User Lut	OFF, EMPTY *4	
Gamut and gamma values are set to menu items with specific values	HLG System Gamma*5	Set HLG System Gamma	1.0,1.1,1.2 (default) ,1.3,1.4,1.5
	D-Log to 709	Set gamut to Rec.709 camera table	OFF,J-Log1,Log-C,S-Log2,C-Log,V-Log,RedLogFilm,S-Log3,User-Log
	D-Log to PQ	Camera table when gamut is set to Rec.2020 and gamma value is PQ1000	OFF, ARRI_LogC_PQ,Canon_CLog2Cin_PQ, Canon_CLog3Cin_PQ,Panasonic_VLog_PQ, RED_L3G10_PQ,Sony_SLog3_Cin_PQ, Sony_SLog3_SG3_PQ
	D-Log to HLG	Camera table when gamut is set to Rec.2020 and gamma value is HLG1000	OFF,ARRI_LogC_HLG,Canon_CLog2Cin_HLG, Canon_CLog3Cin_HLG,Panasonic_VLog_HLG, RED_L3G10_HLG,Sony_SLog3_Cin_HLG, Sony_SLog3_SG3_HLG
Partition HDR/SDR *6	Partition HDR/SDR on, off	OFF,ON	
Color temp	Set screen display color temperature values	D55, D65, D75, D93, DCI, USER1, USER2	
User temp	Set the user color temperature value when the color temperature mode is selected as “USER 1/USER2”	4000K~9800K	
G/M	Set the user color temperature value when the color temperature mode is selected as “USER 1/USER2”	-100 ~ +100	
LUT Upload*7	Select the cube file you want to import	None, 3DLut.cube, User Lut(.cube)*8	
User Lut Delete*9	Delete User Lut	None, ALL, EMPTY*4	
Calibration LUT Reset	Select the appropriate cube file to restore to factory settings	NO, 3DLut.cube	

*1 Color gamut

Set the gamut to match the input audio.

*2 Gamma

When Four-screen is selected; the gamma of four signals can be adjusted separately for display

*3 User Lut

Load User Lut, maximum 13 Lut can be displayed in the menu list.

The D-Log to 709, D-Log to PQ, and D-Log to HLG menus are disabled when loading a User Lut.

*4 EMPTY

When there is no User LUT file imported, it will be displayed as an unselectable grey color labeled 'EMPTY.' Once a file is imported, it will display the name of the User LUT.

*5 HLG System Gamma

Display tunable only when Gamma is set to HLG1000

*6 Partition HDR/SDR

Individual color gamut for Partition HDR/SDR, gamma can be adjusted individually, Partition HDR/SDR default color gamut Rec.2020, gamma 2.2.

*7 LUT Upload

Place the cube file that needs to import the monitor in the root directory of the u-disk, insert the u-disk into the USB interface on the front shell of the monitor, and choose to import the corresponding file

*8 User Lut(cube)

When importing files, select "User Lut (.cube)" from the menu. First, create a new folder named "user_lut_files" in the root directory of the u-disk. Then, place the User LUT files in the "user_lut_files" folder for import. Please note that the file type of the User LUT must be a ".cube" file. Additionally, the length of the imported file name should not exceed 32 characters, support 17×17×17 or 33×33×33 User LUT.

*9 User Lut Delete

Users can delete individual LUTs from the User LUTs list according to their needs, and they can also delete all LUTs.

5. Scanning—Setting for picture scan, zoom, etc.

Menu Item	Menu Description	Value
Scanning ^{*1}	Set up a scanning mode that matches the audio to the screen	Pixel To Pixel, Panel Fit, Native
Zoom -in ^{*2}	Set a zoom mode	OFF, Top Left, Top, Top Right, Left, Center, Right, Bottom Left, Bottom, Bottom Right
Freeze Frame ^{*3}	Select an image still mode	OFF, ON
Anamorphic	Select an anamorphic desqueeze ratio	OFF, 1.33X, 1.5X, 1.66X, 1.8X, 2X, 1.33X mag, 1.5Xmag, 1.66Xmag, 1.8X mag, 2X mag
Odd/Even Frame ^{*4}	Set to open odd field or even field	OFF, Odd Frame, Even Frame

*1. Scanning

Panel Fit: Turn on this feature to adapt the video to the entire screen.

Pixel To Pixel only displays the original mode in the specified mode.

*2. **Zoom -in:** Shown below, the image is divided into 9 regions and adjusted to display in sequence.

When the zoom mode is turned on, a rectangle box pops up at the bottom left of the screen, showing the currently selected zoom image area.

Top Left	Top Center	Top Right
Center Left	Center	Center Right
Bottom Left	Bottom Center	Bottom Right

*3 Freeze-frame

When the image freeze-frame is activated, the screen remains static. However, upon enabling the low-latency mode, the image freeze-frame menu is disabled

*4. Odd/Even Frame

Odd/Even Frame is only displayed in I mode. Open Low Latency Mode and Odd/Even Frame function is turned off.

6.Control—Setting for TALLY, UMD, IP control to the monitor

Menu Item	Menu Description	Value
GPI Control *1	Open or close GPI Control	OFF,ON
GPI 1Pin	Set the function of each pin for GPI terminal	SDI1, SDI2, SDI3, SDI4, 4×SDI 2-SI, 4×SDI SQD , HDMI®, Red Tally, Green Tally, Yellow Tally ,Time Code, Freeze Frame, WFM Type, WFM Single Line, UMD, Marker , Waveform, Audio Bar, Zebra, Vector, Low Latency Mode, Histogram,Lissajous, Focus Assist , False Color
GPI 2Pin		
GPI 3Pin		
GPI 4Pin		
GPI 5Pin		
GPI 6Pin		
Tally Setting	Switch on/off Tally light	OFF, ON, Blinking
Tally Position	Set the display position of On Screen Tally Lamp	Top, Bottom
F1*2	Set the control function of the function key	SDI1, SDI2, SDI3, SDI4, 4×SDI 2SI, 4×SDI SQD, HDMI®, Time Code, Color Temp, Freeze Frame , Waveform, WFM Type , WFM Single Line, UMD, Marker, H/V Delay, Blue Only, Audio Bar, Zebra, Vector, Histogram, Odd/Even Frame ,Lissajous, Focus Assist ,False Color,CIE
F2		
F3		
F4		
F5		
UMD *3	Open or close UMD display	OFF, ON
UMD Color	Set the color of UMD characters	White,Red,Green,Blue,Black,Gray
UMD Position	Set the position of UMD characters	Top,Bottom
UMD Size	Set the size of UMD characters	Large, Small
UMD Blending	Show the transparency of the UMD background	OFF, LOW, HIGH
Display Type	Set display UMD or source name characters	Source ID, TSL3.1,TSL4.0
RS485 Address*4	Set the location of RS485	1~126
Baud Rate	Fixed for 115200	115200,8,n,1/ 38400,8,n,1/ 9600,8,n,1
Source ID	Set the character that the source name displays	A-Z, a-z, 0-9, [\]^_`{ }~@?>=<.,/.-+* ()' &%\$#' ' !

*1 GPI control

Connect the GPI remote control terminal through the GPI interface on the real panel of the monitor, turn on “GPI control” and set the function of GPI 1-6 buttons.

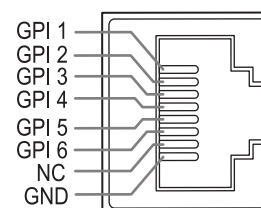

The GPI control allows you to control both the Tally light and the on screen TALLY light on at the same time:

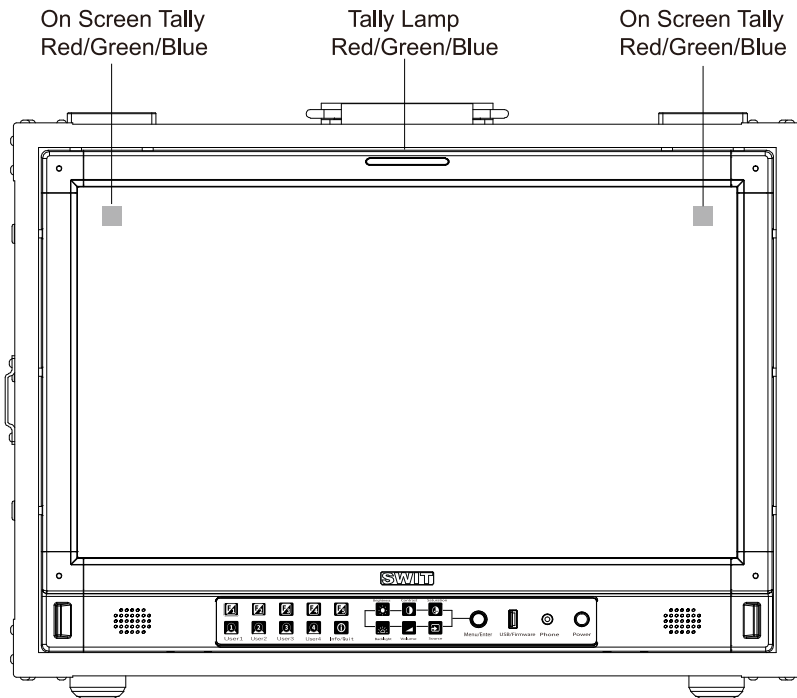

*2 function button

Different channels can be selected via the F1~F5 buttons on the front panel. (SDI1, SDI2, SDI3, SDI4, 4×SDI 2SI, 4×SDI SQD, HDMI®)。

*3 UMD

Select the display type as “TSL3.1or 4.0”, which can be controlled with TSL UMD.

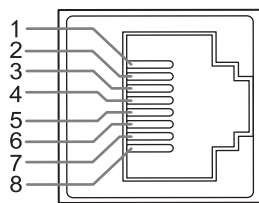

RS485 IN

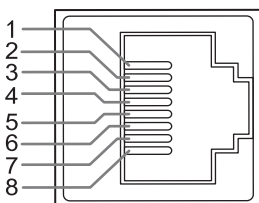

RS485 OUT

Pin No	RS 485 IN	RS 485 OUT
1	GND	GND
2	NC	NC
3	RXD-	RXD-
4	NC	NC
5	NC	NC
6	RXD+	RXD+
7	TXD-	TXD-
8	TXD+	TXD+

Cascade:

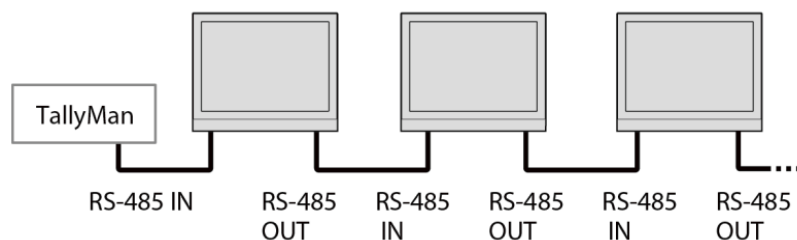

*4 RS485 address

When Multi-screen-"4-screen or 2-screen" is selected, if screen 1/2/3/4 or screen 1/2 are set to different addresses, the UMD of a single screen can be controlled separately

7. Assist-Setting for Vector scope and Histogram patterns.

Menu Item		Menu Description	Value
False Color		Turn false color display on or off	OFF, ON
Blue Only		Turn blue only on or off	OFF, ON
Focus Assist		Turn on or off focus assist and adjust the color of the focus assist	OFF, Blue, Red
Zebra		Turn zebra on or off	OFF, ON
Waveform	Waveform	Turn waveform on or off	OFF, ON
	WFM Type	Set the WFM Type	Y, Cb, Cr, R,G,B,RGB
	WFM Position	Set the WFM position	Bottom Left, Bottom Right, Top Left, Top Right
	WFM Blending	Set the blending of the background color of the waveform	OFF, High, Low
	WFM Brigh	Set the brightness within a WFM image	Low, Medium, High
	WFM Color	Set the color of the waveform displayed on the waveform chart	White, Green, Color
	WFM Single Line ¹	Switch on single line waveform	OFF, ON
	WFM Line Count	Set a line for the single line waveform	1-1080
Vector	Vector	Turn vector on or off	OFF, ON
	Vector Position	Adjust the position of the vector on the screen	Bottom Left, Bottom Right, Top Left, Top Right
	Vector Blending	Vector scope transparency selection	OFF, LOW, HIGH
	Vector Brigh	Set the brightness within a vector image	Low, Medium, High
	Vector Color	Set vector colors	White, Green, Color
CIE	CIE	Turn the color gamut chart on or off	On,Off
	CIE Position	Adjusting the position of the color gamut map on the screen	Top left, Top right, Bottom left, Bottom right
	CIE Blending	Set the transparency of the background color of the color gamut map	Off, Low, High
	CIE Bright	Set the brightness within the color gamut map chart	Low, Medium, High
	CIE Color	Set gamut map colors	White, green, color
Histogram	Histogram	Turn histogram on or off	OFF, ON
	Histogram Position	Set the display position on the histogram screen	Top left, Top right, Bottom left, Bottom right
	Histogram Blending	Set the transparency of histogram background color	OFF, LOW, HIGH
Marker	Marker	Turn marker on or off	OFF, ON
	Marker Select	Set the scale of the market line	16:9,15:9,14:9,13:9,4:3,2.35:1,2:1, 1.85:1,2.39:1, USER1, USER2
	Horizontal(user 1) ²	Set the X – axis value of the marker	50%~99%
	Vertical(user 1)	Set the Y – axis value of the marker	50%~99%
	Horizontal(user 2) ³	Set the X – axis value of the marker	0~1920
	Vertical(user 2)	Set the Y – axis value of the marker	0~1080
	Safety area	Set safety area percentage	80%~100%
	Fit Marker	Set safety area to fit marker ratio or not	OFF, ON
	Center Marker	Switch on the center cross marker	OFF, ON
	Marker Color	Select a color for marker	White, Red, Green, Blue, Black, Gray
	Marker type	Set the display type of marker	Type 1, Type 2
Marker outside	Marker outside color setting	OFF, Black, Gray	
Eye pattern ⁴		Turn eye pattern on or off	ON,OFF

*1 WFM Single Line

Open waveform single-line mode, the monitor shows only one line of audio waveform. Rotate the Menu/Enter knob to select the number of lines of audio signal to display the waveform. (The selection range of the number of lines in a waveform depends on the current signal standard)

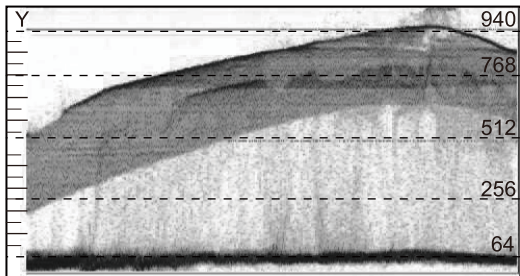

WFM Single Line:OFF

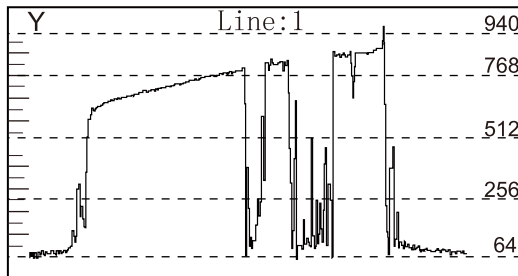

WFM Single Line:ON

* 2 Horizontal / Vertical (user 1)

When the value of the scale item is set to "User 1", the user can adjust the X position and Y position of the marking line according to his/her own needs, and the coordinate value can be adjusted in the range of 50%~99%;

*3 Horizontal / Vertical (User 2)

When the value of the scale item is set to "User 2", users can adjust the X position and Y position of the marking line according to their own needs, and the X coordinate value can be adjusted in the range of 0~1920, and the Y coordinate value can be adjusted in the range of 0~1080.

*4 Eye pattern

Only SDI1 supports eye diagram to monitor the image quality of the current SDI video signal after transmission over the cable, especially the transmission quality of 12G-SDI.

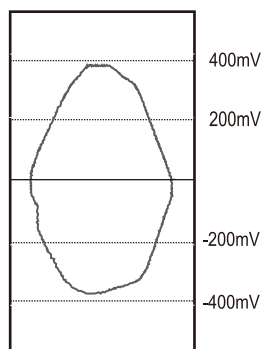

Good Signal

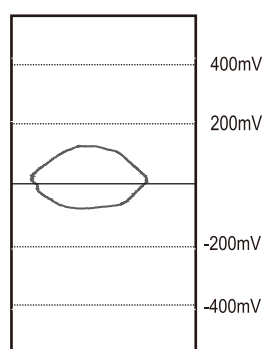

Bad Signal

8. De-embed— Setting for video/audio analysis functions

Menu Item	Menu Description	Value	
Audio Meter	Audio Meter	Turning audio meters on or off	ON,OFF
	Audio meter Position	Adjusting the position of the audio meter on the screen	Top Left, Top Right, Bottom Left, Bottom Right
	Audio meter Blending	Set the transparency of the audio meter background color	OFF,LOW,HIGH
	Audio meter marker *1	Setting the audio meter marker line	ON,OFF
Lissajous	Lissajous Pattern	Turn on or off Lissajous figure	ON,OFF
	Lissajous position	Set the position of the Lissajous position on the screen	Top Left, Top Right, Bottom Left, Bottom Right
	lissajour Blending	Set the Blending of the Lissajous background color	Off, Low, High
Surround Phase	Surround Phase	Turn surround Phase on or off	ON,OFF
	Surround Position	Adjusting the position of the surround sound display on the screen	Top Left, Top Right, Bottom Left, Bottom Right
	Surround type	Selecting the type of surround sound	5.1,
	Surround Blending	Set the transparency of the surround sound background color	OFF,LOW,HIGH
Left Channel*2	Select the left channel output channel	Channel 1~16	
Right Channel	Select the right channel output channel	Channel 1~16	
Volume	Adjust audio volume	0~100	
Time code	Turn on/off Time code	OFF, ON	
H/V Delay*3	Turn on/off H/V Delay	OFF, ON	

*1. Audio meter marker

Audio table display, display 16 channel audio table

Marking line off: Only the audio table is displayed

Marking line on: Display audio decibels, audio alarm signal and left and right channel options

Marking line: off

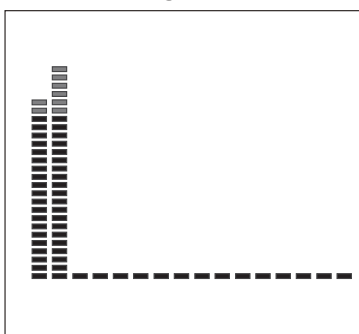

Marking line: on

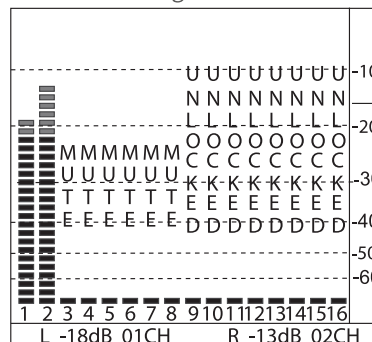

Left Channel:1 Green

Right Channel:2 Red

*2. Left Channel/ Right Channel

Audio meter under SDI showing 16 channel audio meter

Audio meter under HDMI®, menu shows 8 groups of channels

*3. H/V Delay

H/V Delay is not displayed on HDMI® channel.

9. Auto Calibration*¹

Menu Item	Menu Description	Value
Probe Select* ²	Select a probe to use	X-rite I1 Pro OEM, Jeti Specbos 1211
Start Calibration* ³	Select whether to start calibration	No/Yes
Measure* ⁴	Test current color	No/Yes

*1.Auto Calibration

The monitor has built-in 3DLUT color calibration software, which supports Atheros X-rite I1 Pro OEM and JETI Specbos1211 color probes directly connected to the monitor via USB.

When calibration starts, the color probe will read the standard color graphics generated by the monitor and load the results to the monitor via the USB port.

The monitor internally compares the standard colors with the colors read by the probe to generate a 3DLUT table and complete the automatic color calibration.

Calibration time: X-rite I1: 15 minutes, JETI Specbos1211: 45 minutes.

Calibration result Delta E <1.0.

*2.Probe Select

This monitor supports the following probes models:

BRAND	Model
X-rite	I1 Pro OEM (SWIT OEM)
JETI	Specbos 1211



X-rite I1
(SWIT Exclusive Edition only)



JETI Specbos 1211

*3.Start Calibration

Steps:

1. Put the monitor into a dark room. Switch on the monitor.
2. Connect the calibration instrument (compatible with x-rite and JETI color measuring instruments) and monitor via USB. Before calibration, ensure that the monitor and the color calibration instrument are in good condition and the monitor aging time reaches 30 minutes.
3. Enter the “Probe Select” and select the currently used calibration probe.
4. Enter the “Start Calibration” and select “yes” to start calibration. The monitor will display the prompt message and the color position prompt box. Put the sensitive part of the device in the color position prompt box correctly. Note that when placing the calibration instrument; do not squeeze the monitor’s LCD screen.

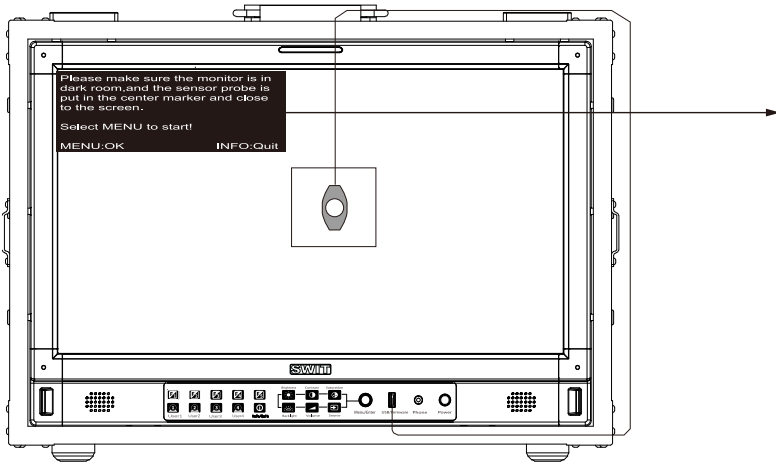

Please make sure the monitor is in dark room, and the sensor probe is put in the center marker and close to the screen.

Select MENU to start!

MENU:OK

INFO:Quit

5. Select "yes" to begin auto calibration. The color calibration instrument will automatically measure the color of the screen and correct the color of the screen. During this process, it is necessary to observe the color calibration progress bar in the color correction prompt box.
6. Press "INFO" to terminate the color correction process at any time. When the prompt color calibration progress reaches 100%, the whole automatic color calibration is completed. After automatic color correction, press the "INFO" button to exit the menu and let the monitor enter the normal display mode.
7. After the automatic color correction, the display screen pops up "Before Calibration" and "After Calibration".

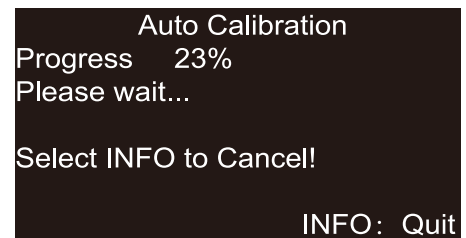

*4. Measure

The monitor has been calibrated in factory. And may need to be re-calibrated after a period of time. Before re-calibrated, the measure function can check the current color to compare with the last time calibrated color, to decide if the monitor needs to be re-calibrated. Connect with the sensor probe and place the sensor probe onto the right position like calibration step. Enter "Auto Calibration" – "Measure". The monitor will generate several colors and finish measure within 30 seconds. And display the result as:

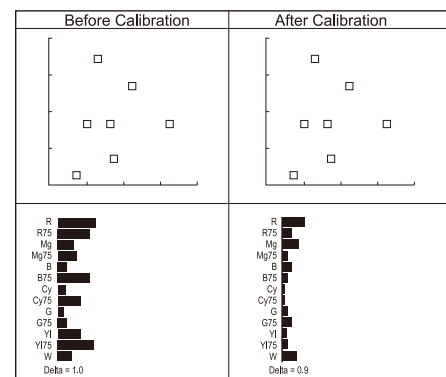

CIE and Delta E before calibration

CIE and Delta E after calibration

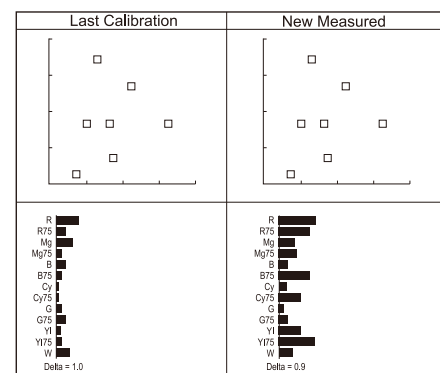

CIE and Delta E from last calibration

CIE and Delta E from new measured

10. System-User profile saving,firmware update.

Menu Item	Menu Description	Value
Key Lock ^{*1}	Set lock key	OFF, Full Lock
Recall Profile ^{*2}	Select make user mode current	Factory,USER1,USER2,USER3,USER4
Save Profile	Save the current state as a user setting	USER1,USER2,USER3,USER4
Payload ID	When turned on, Payload ID information conforming to SMPTE ST 352 standard is automatically adapted	OFF, ON
Low Latency Mode	Open or close low latency mode	OFF, ON
Green mode	Set the display mode of green mode	Black Backlight, Gray Backlight
Idle Duration	Set how long it will be in the no-signal state and turn on green mode	30 Sec, 1 Hour, 2 Hours, 4 Hours, OFF
IP ^{*3}	Set up the monitor IP address to achieve remote web control	192.168.001.200
Net Mask		255.255.255.000
Gateway		192.168.001.001
Port(1024~65535)		08080
OSD TIME	Set OSD display time	5~180
Key Brightness	Set the brightness of the key lamp	OFF, Low, High
Language	Select Chinese or English language to display	Chinese, English
System Reset	Reset all Settings in the menu system	No/Yes
Update ^{*4}	Set whether to upgrade firmware	No/Yes

*1.Key Lock

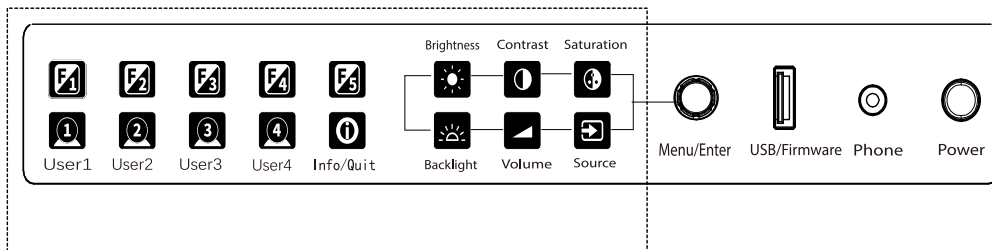

ALL

The “Menu/Enter” button can be operated when the button is locked. “Key Locked” will be displayed on the screen when you press the Locked button or knob.

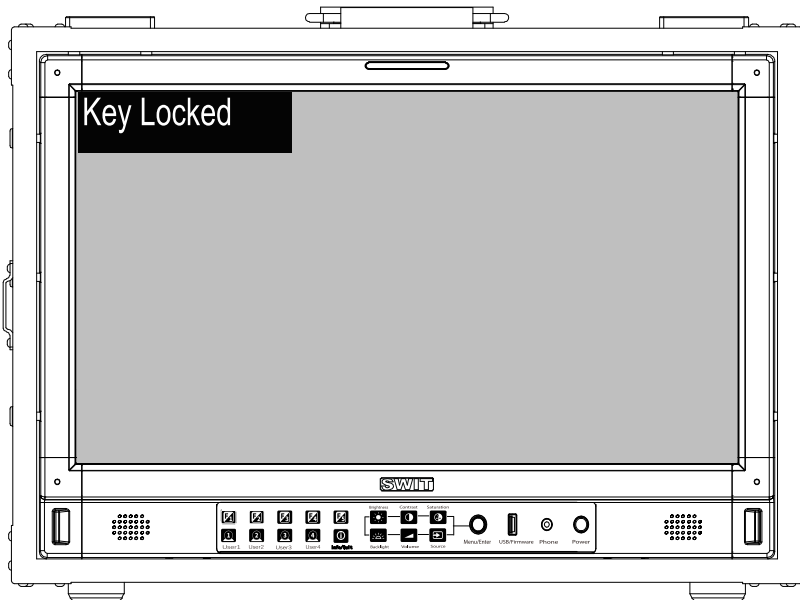

*2 Recall Profile/ Save Profile

User Settings provide 4 menu Settings, that is, users can save the current monitor menu Settings as one user Settings (USER1~USER4) according to usage habits. Then, when switching menu Settings, just select the corresponding "USER1~USER4" through the "Recall Profile" item to display the corresponding menu Settings. Example: By adjusting the parameters of the color temperature of 2200K, open the necessary auxiliary functions (such as: histogram), set the function key to the desired menu (such as F1 is set to "Blue Only"), and so on, the monitor Menu Settings can be "USER Settings" save as "USER" 1, rotating the "Menu/Enter" choose to load the USER Settings "set to the current" USER 1 "mode, the monitor Menu item value will show" USER 1 "mode to save Menu.

*3 IP control

Connect the monitor to the LAN through an ETHERNET interface, and the Monitor can be controlled by web page.

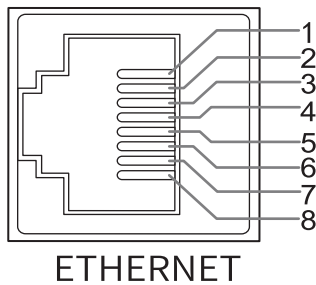

Pin No	Pin Name
1	MD0P
2	MD0N
3	MD1P
4	MD1N
5	MD2P
6	MD2N
7	MD3P
8	MD3N

Enter Menu- System – IP/Net Mask/Gateway/Port to set the monitor address. Set the computer Ethernet IP addresses at the same LAN environment as the Monitor. Launch any of a web browser on the computer, and enter URL: Monitor IP+ Port (Example: 192.168.1.99.8080). The web server control page will be displayed.

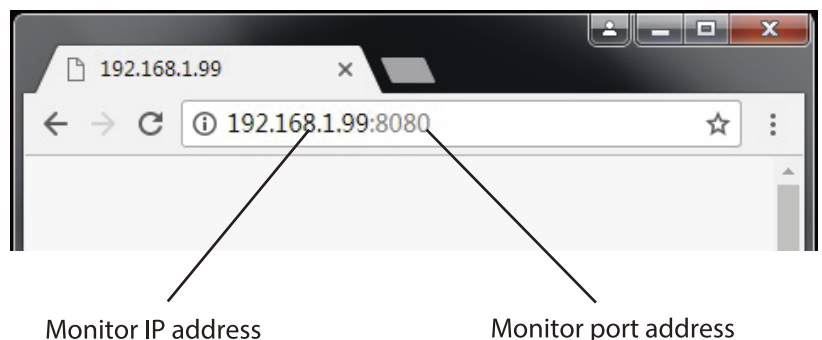
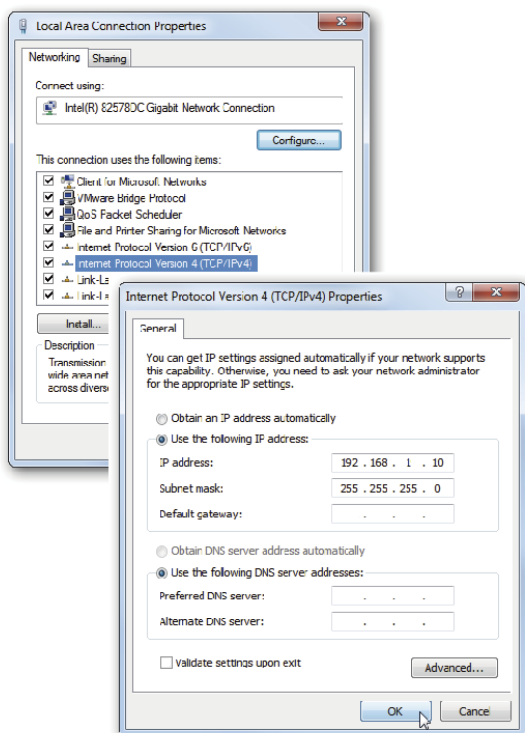

Fig1: IP Address setting

Fig2: Web page

- Used crossed wired cable for computer-monitor directly connection.
- Use straight-through wired cable for Router connections.
- Please seek help from your webmaster for any network connections.

Webserver page control interface

SWIT.

The screenshot shows the main control interface with the following sections:

- Status:** Input Source: HDMI; Input Format: 1920*1080P60; Loaded Profile: USER 1; Video Level Range: 64-940; YUV Color Matrix: BT.709; Volume: 18; Chroma: 0; Bright: 0; Contrast: 0; Freeze Frame: OFF; Odd/Even Frame: OFF; Low Latency: OFF; Gamma: 2.2; Color Temp: D65; Log Mode: OFF; Monitor IP: 192.168.1.200; Net Mask: 255.255.255.0; Gateway: 192.168.1.1; Port: 8080; Refresh Status button.
- Settings:** Input Source (SDI1-4, SQ, 2-SI, SFP, HDMI); Loaded Profile (USER 1); Function Key (F1-F6); Volume slider (0-100, 18); Chroma slider (-100-100, 0); Brightness slider (-100-100, 0); Contrast slider (-100-100, 0); Frame (Freeze Frame OFF, TopHalf, BottomHalf, Full); Odd/Even Frame (Odd, Even OFF); Low Latency (ON, OFF); Color (VideoLevelRange 64-940, YUVColorMatrix Auto, Gamma 2.2, Color Temp D65).
- Network:** (indicated by a red dashed line)
- Update:** (indicated by a red dashed line)

After setting up, click this brush
New View the latest Settings

The Network settings page includes:

- Settings | Network | Update
- Monitor IP: 192.168.1.200
- Net Mask: 255.255.255.0
- Gateway: 192.168.1.1
- Port: 8080 [Set] 1024-85535

The Update page includes:

- Settings | Network | Update
- Current Version: v5.20190319r
- Notes:
 1. Please make sure you have the update zip package on your PC.
 2. Recommend to do Firmware updates only with AC power support.
 3. Never shutdown the power during updating progress.
- Please following these instructions:
- Search a new update zip package on your PC: [浏览...] 未选择文件。
- Press 'submit' to transfer it to the monitor: [submit]
- Now ready to install, press 'Update': [Update]

*4.Update

System software can update by USB interface, and steps are as follows:

- 1.Download the latest software package into the U-disk root direction.
- 2.Open the monitor and plug U-disk into USB into port.
- 3.Follow the step “Menu-System-Update”, the monitor will update automatically.
- 4.When update finishes, press “Power” button, close and reboot the monitor.

	<p>※ Remark</p> <ol style="list-style-type: none">1. Only copy one model and software version into the U-disk root direction.2. Never shutdown the power during the update progress.
---	---

11. Multiview setting^{*1}

Menu item	Menu description	Value
Multiview type ^{*2}	Selects the Multiview typ	Quad view, PBP H/H, PBP V/V ^{*3} , PBP H/V, PBP V/H, PIP
PIC 1	Select channel 1 when set to PBP or PIP.	SDI 1、SDI 2、SDI 3、SDI 4、HDMI®
PIC 2	Select channel 2 when set to PBP or PIP	SDI 1、SDI 2、SDI 3、SDI 4、HDMI®
PIP Windoe position	Select PIC2 position when set to PIP	Bottom Left、Bottom Right、Top Left、Top Right、Centre
Border	Switch on/off the border	On/OFF

*1 Multiview setting

Source selects Multi-screen before the Multi-screen Setup menu is adjustable and some menu functions are disabled;

When Multi-screen is selected, the quantisation range, color gamut and gamma of each channel can be adjusted individually.

*2 Multiview type

4-channel or 2-channel independent 12G/6G/3G/HD-SDI or HDMI® mixed 4-screen or 2-screen monitoring;

4-screen: If there is no signal input on the 4th screen, HDMI® signal appears on the 4th;

*3 PBP V/V

To select the desired type for dual-screen display, the screen can be set to portrait mode for monitoring.

Appearance and Size

Flight Case Monitor Appearance

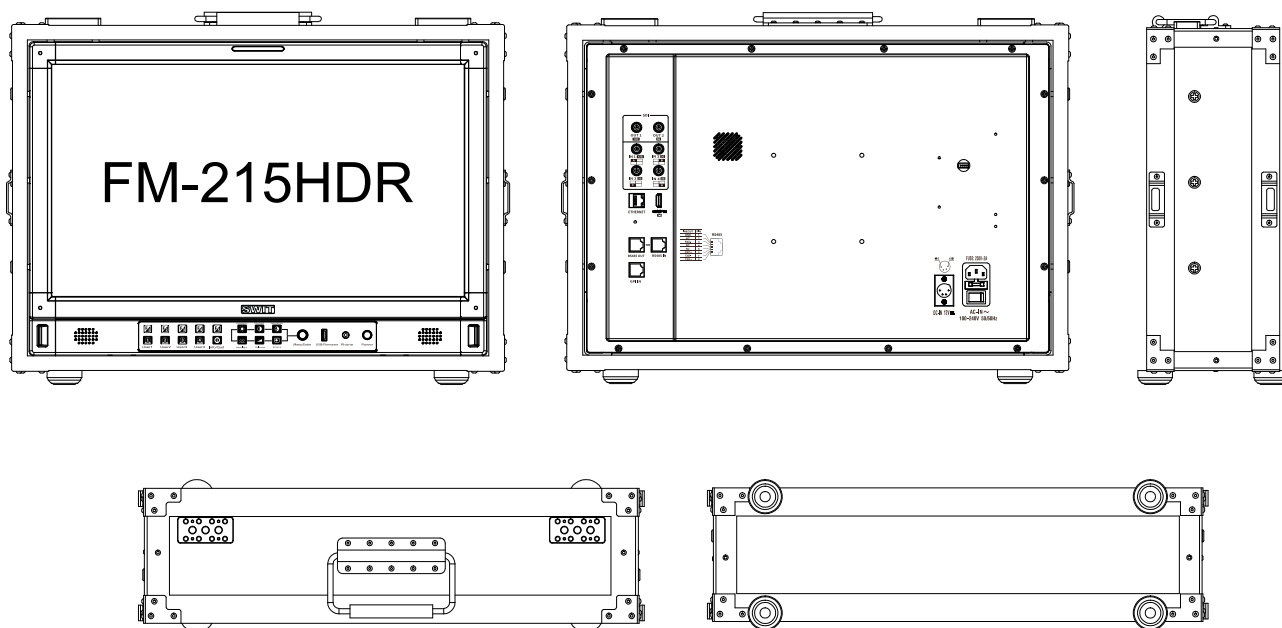

Aluminium flight case (unit: mm)

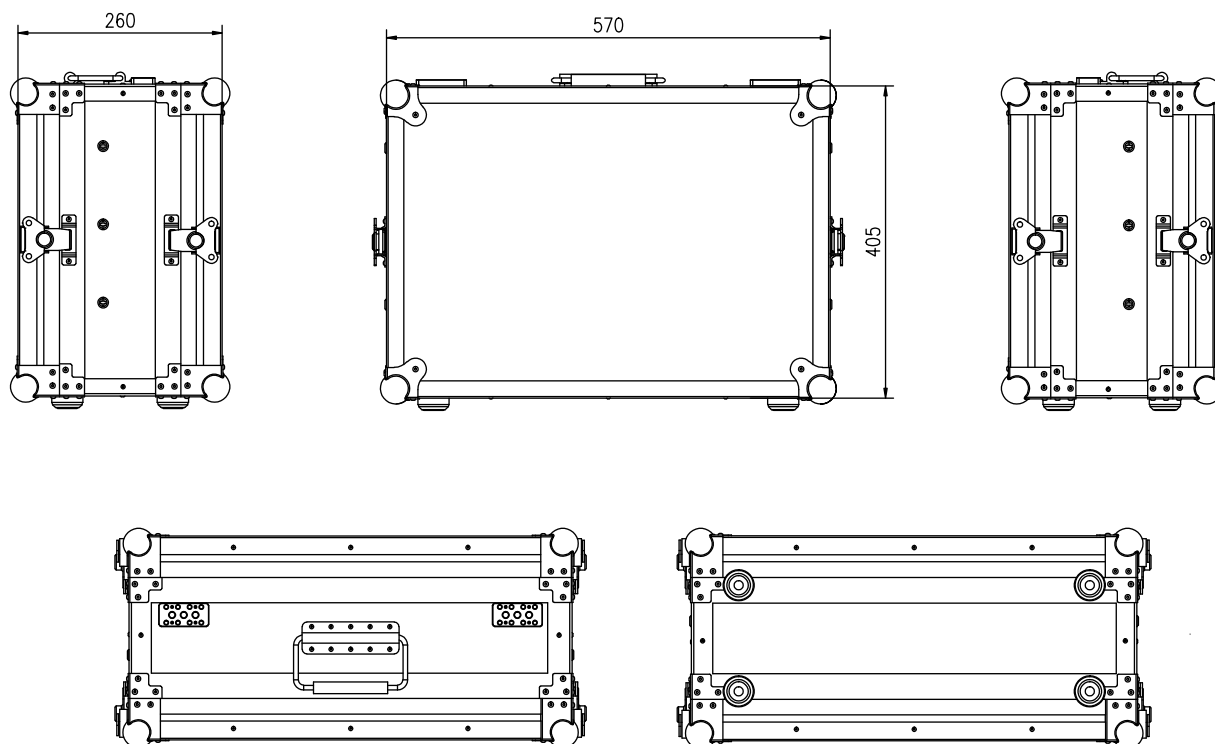

Specification

Model No.	FM-215HDR	
Screen Size	21.5 inch	
Display Area	476.064×267.786mm	
Resolution	1920×1080	
Display color	16.7M	
Display Ratio	16:9	
Maximum Brightness	1000 cd/m ²	
Contrast Ratio	1000:1	
color depth	8bit	
Signal Processing	18-bit	
Viewing angle H/V	178°/178°	
Input/Output Interface		
Input	BNC×4	12G/6G/3G/HD/SD-SDI×1, 3G/HD/SD-SDI×3
	HDMI®×1	HDMI®2.0 input
	RS-485×1	TSL3.1/4.0 UMD dynamic source name input
	RS-485×1	GPI (Tally) input
	USB×1	
	RJ-45×1	Gigabit Ethernet port, IP web control access
Output	BNC×2	12G/6G/3G/HD/SD-SDI×1, 3G/HD/SD-SDI×1
	RS-485×1	TSL3.1/4.0 UMD dynamic source name output
	Analog audio	Analog audio 3.5mm and speaker output
Other specifications		
Operating Voltage AC	100V~240V 50/60Hz	
DC/Battery	11V~17V	
Power consumption	≤60W	
Operating Temperature	0°C~+45°C	
Operating humidity	10%~90%	
Storage temperature	-15°C~ + 60°C	
Storage humidity	10%~90%	
flight box size	570×260×405mm	
Net weight (main unit only)	7.28KG	
Net weight of flight box	6.8KG	

Supported standards: Signals of the following standards can be displayed on the monitor

No.	Format	Input terminal				Signal format shown in the Status Display as		
		SDI1	SDI 2/3/4	Quadlink SDI	HDMI®	SDI1 out	SDI2 out	HDMI®
1	1280×720/50P	√	√	—	√	1280*720P50	1280*720P50	1280*720P50
2	1280×720/59.94P	√	√	—	√	1280*720P59.94	1280*720P59.94	1280*720P60
3	1280×720/60P	√	√	—	√	1280*720P60	1280*720P60	1280*720P60
4	1920×1080/50I	√	√	—	√	1920*1080I50	1920*1080I50	1920*1080I50
5	1920×1080/59.94I	√	√	—	√	1920*1080I59.94	1920*1080I59.94	1920*1080I60
6	1920×1080/60I	√	√	—	√	1920*1080I60	1920*1080I60	1920*1080I60
7	1920×1080/23.98PSF	√	√	—	√	1920*1080PSF23.98	1920*1080PSF23.98	1920*1080PSF24
8	1920×1080/24PSF	√	√	—	√	1920*1080PSF24	1920*1080PSF24	1920*1080PSF24
9	1920×1080/23.98P	√	√	—	√	1920*1080P23.98	1920*1080P23.98	1920*1080P24
10	1920×1080/24P	√	√	—	√	1920*1080P24	1920*1080P24	1920*1080P24
11	1920×1080/25P	√	√	—	√	1920*1080P25	1920*1080P25	1920*1080P25
12	1920×1080/29.97P	√	√	—	√	1920*1080P29.97	1920*1080P29.97	1920*1080P30
13	1920×1080/30P	√	√	—	√	1920*1080P30	1920*1080P30	1920*1080P30
14	1920×1080/48P	√	√	—	√	1920*1080P48	1920*1080P48	1920*1080P48
15	1920×1080/50P	√	√	—	√	1920*1080P50	1920*1080P50	1920*1080P50
16	1920×1080/59.94P	√	√	—	√	1920*1080P59.94	1920*1080P59.94	1920*1080P60
17	1920×1080/60P	√	√	—	√	1920*1080P60	1920*1080P60	1920*1080P60
18	2048×1080/23.98PSF	√	—	—	√	2048*1080PSF23.98	—	2048*1080PSF24
19	2048×1080/24PSF	√	—	—	√	2048*1080PSF24	—	2048*1080PSF24
20	2048×1080/25PSF	√	—	—	√	2048*1080PSF25	—	2048*1080PSF25
21	2048×1080/29.97PSF	√	—	—	√	2048*1080PSF29.97	—	2048*1080PSF30
22	2048×1080/30PSF	√	—	—	√	2048*1080PSF30	—	2048*1080PSF30
23	2048×1080/23.98P	√	—	—	√	2048*1080P23.98	—	2048*1080P24
24	2048×1080/24P	√	—	—	√	2048*1080P24	—	2048*1080P24
25	2048×1080/25P	√	—	—	√	2048*1080P25	—	2048*1080P25
26	2048×1080/29.97P	√	—	—	√	2048*1080P29.97	—	2048*1080P30
27	2048×1080/30P	√	—	—	√	2048*1080P30	—	2048*1080P30
28	2048×1080/47.94P	√	—	—	√	2048*1080P47.94	—	2048*1080P50
29	2048×1080/48P	√	—	—	√	2048*1080P48	—	2048*1080P48
30	2048×1080/50P	√	—	—	√	2048*1080P50	—	2048*1080P50
31	2048×1080/59.94P	√	—	—	√	2048*1080P59.94	—	2048*1080P60
32	2048×1080/60P	√	—	—	√	2048*1080P60	—	2048*1080P60
33	3840×2160/23.98P	√	—	√	√	3840*2160P23.98	—	3840*2160P24
34	3840×2160/24P	√	—	√	√	3840*2160P24	—	3840*2160P24
35	3840×2160/25P	√	—	√	√	3840*2160p25	—	3840*2160p25
36	3840×2160/29.97P	√	—	√	√	3840*2160P29.97	—	3840*2160P30
37	3840×2160/30P	√	—	√	√	3840*2160P30	—	3840*2160P30
38	3840×2160/47.94P	√	—	√	√	3840*2160P47.94	—	3840*2160P50
39	3840×2160/48P	√	—	√	√	3840*2160P48	—	3840*2160P48

No.	Format	Input terminal				Signal format shown in the Status Display as		
		SDI1	SDI2/3/4	Quadlink SDI	HDMI®	SDI1 out	SDI2 out	HDMI®
40	3840×2160/50P	√	—	√	√	3840*2160P50	—	3840*2160P50
41	3840×2160/59.94P	√	—	√	√	3840*2160P59.94	—	3840*2160P60
42	3840×2160/60P	√	—	√	√	3840*2160P60	—	3840*2160P60
43	4096×2160/23.98P	√	—	√	√	4096*2160P23.98	—	4096*2160P24
44	4096×2160/24P	√	—	√	√	4096*2160P24	—	4096*2160P24
45	4096×2160/25P	√	—	√	√	4096*2160P25	—	4096*2160P25
46	4096×2160/29.97P	√	—	√	√	4096*2160P29.97	—	4096*2160P30
47	4096×2160/30P	√	—	√	√	4096*2160P30	—	4096*2160P30
48	4096×2160/47.94P	√	—	√	√	4096*2160P47.94	—	4096*2160P48
49	4096×2160/48P	√	—	√	√	4096*2160P48	—	4096*2160P48
50	4096×2160/50P	√	—	√	√	4096*2160P50	—	4096*2160P50
51	4096×2160/59.94P	√	—	√	√	4096*2160P59.94	—	4096*2160P60
52	4096×2160/60P	√	—	√	√	4096*2160P60	—	4096*2160P60

3G supports level A/levelB; Support RGB444

√: The format is supported
 —: The format is not supported

Common Problems and Solutions

symptom	Possible causes	Solution
No display	The power is not turned on	Please check if the power is connected, and then press “POWER” button to turn on the monitor
	Unstable power voltage	Reconnect to power supply
	BNC or HDMI® cable loose contact or not correctly connected	Check and correctly connect the BNC or HDMI® cable
	The attached battery is no power	Change battery
	Using DIY power supply but the polarity is reversed	Refer to the provided power supply, reconnect the power.
Image or color abnormal	Bad contact of BNC or HDMI® cable	Change the Video cable
	Video signal has Interference	Remove the interference source(s)
	Improper adjustment of the color parameters	Adjust the “Recall profile” to “Default” under “System” submenu
	Distortion of the image	Reset the Aspect ratio
	Set to Blue only	Turn off the “pure color “ setting
	Turn on the “Focus Assist” function	Turn off the “Focus Assist” function
	Turn on the “False Color” function	Turn off the “False Color” function
No audio output	Set mute state	Cancel mute state or spin ” MENU/ENTER ” to adjust volume
	Bad contact of signal cable	Change signal cable
	Wrong connection or bad contact of Audio cable	Connect to the correct input socket
USB flash drive not recognized	Poor compatibility between USB flash drive and system	Reboot the monitor or replace the USB flash drive

SWIT®

SWIT Electronics Co., Ltd.

Add: 10 Hengtong Road, Xin'gang, Nanjing Economic and
Technological Development Zone, Nanjing 210038, P.R.China
Tel: +86-25-85805753 Email: contact@swit.cc